

SEC-ASD-531

Aspirating Smoke Detector

Operating Manual
FW version 01.04.xx



Manufacturer:

Securiton AG
Alpenstrasse 20
3052 Zollikofen, Switzerland
www.securiton.ch

The product (hardware, software and technical documentation) is subject to the copyright of the manufacturer. Any prohibited modification, misuse, copying or prohibited sale of this product represents a violation of the copyright and will be legally prosecuted.

Copyright by Securiton AG

Validity



Notice

This document is valid only for the product described in this chapter and may be changed or withdrawn without prior notice. The validity of the statements made in this document applies until the statements are revised by a new edition of the document (T number with new index). The user of this document is responsible for staying up to date with its current status through the editor/publisher. We accept no responsibility for claims against any incorrect statements in this document that were unknown to the publisher at the time of publication. Handwritten changes and additions are invalid.

Foreign language documents as listed in this document are always released or changed at the same time as the German edition. If there are inconsistencies between the foreign language document and the German document, the German text is binding.

Some words in this document are highlighted in **blue**. These terms and designations are the same in all languages and are not translated. Users are encouraged to contact the editor/publisher if there are statements which are unintelligible, misleading, incorrect or which contain errors.

This document is intended for trained specialists for mounting, installation, commissioning and maintenance of the product.

This document is available in the following languages:

German	T811 168 de
English	T811 168 en
French	T811 168 fr
Italian	T811 168 it
Spanish	T811 168 es
Portuguese	T811 168 pt
Swedish	T811 168 sv
Norwegian	T811 168 no
Finnish	T811 168 fi
Danish	T811 168 da

Current edition:

Index e

25.09.2023

Hpa/Rd



Notice

The following documentation is applicable to the ASD 531 aspirating smoke detector with the following production version and firmware version:

Production version
from 131221

Firmware version
01.04.xx

Table of contents

1	Legal notice / Warnings	9
1.1	General	9
1.2	Smoke sensors used	9
1.3	Hardware / Firmware	9
1.4	Planning	10
1.5	Electrical installation	10
1.6	Fire tests	11
1.7	Maintenance and service	11
1.8	Environmental influences	12
1.9	Sampling pipe	12
1.10	Disposal	13
1.10.1	Materials used	13
2	General	14
2.1	Uses and applications	14
2.2	Abbreviations and terms	15
2.3	Product identification	15
2.4	List of materials / components	16
2.4.1	Scope of Delivery	16
2.4.2	Detector Housing Options	16
2.4.3	Sampling pipe	16
2.5	Packaging	16
2.6	Tools for handling the detector housing	16
2.7	Document Index	16
3	Design and function	17
3.1	Block diagram of device with explanation of the basic functions	17
3.1.1	Power supply	17
3.1.2	Fan control	17
3.1.3	Indicators	18
3.1.4	Rotary switch "Mode" switch positions	18
3.1.5	Relay	18
3.1.6	Outputs	18
3.1.7	Input	18
3.1.8	Interfaces	19
3.1.9	Airflow monitoring	19
3.1.10	Alarm release	19
3.1.11	Fault triggering	19
3.1.12	Event memory	19
3.1.13	State reset	20
3.1.14	Hardware reset	20
3.1.15	Initial reset	20
3.1.16	Configuration	20
3.2	Mechanical design	21
3.3	Electrical design	23
3.3.1	AMB 31 Main Board	24
3.4	Optional accessories (internal) XLM / ML-SFD, RIM, SD card	25
3.4.1	XLM 35 SecuriLine eXtended Line Module	25
3.4.2	ML-SFD SecuriMultiLine-Module	25
3.4.3	RIM 36 Relay Interface Module with 5 relays	26
3.4.4	SD memory card	26
3.5	Optional accessories (external), filters etc.	27
3.5.1	Sampling pipe	27
3.5.2	Use under extreme conditions	27

4	Planning bases	28
4.1	System limits	28
4.2	BasiConfig or ASD PipeFlow?	28
4.2.1	BasiConfig	28
4.2.2	PipeFlow	28
4.3	Space surveillance applications	30
4.3.1	Examples of application	30
4.3.2	Principles of space surveillance	30
4.3.3	Maintenance sampling hole	30
4.3.4	Symmetrical tube networks (with BasiConfig or ASD PipeFlow)	31
4.3.5	Tube topologies with system limits	31
4.3.6	Hole diameter increment	32
4.3.7	Asymmetrical tube networks (only with ASD PipeFlow)	33
4.3.8	Example of asymmetrical tube network	33
4.4	Equipment monitoring applications (only with ASD PipeFlow)	34
4.4.1	Examples of application	34
4.4.2	Basics	34
4.4.3	Sampling fixtures and sampling holes in equipment monitoring	35
4.5	Tips and notices on planning	36
4.6	Use according to ULC	36
4.6.1	Use according to ULC-S529 3 rd Ed	36
5	Installation of device and sampling pipe	37
5.1	Device	37
5.1.1	Tools for handling the detector housing	37
5.1.2	Installation location of the detector housing	37
5.1.3	Dimensions, drilling plan, entries, etc.	39
5.1.4	Installation of the detector housing	40
5.1.5	Turning the labelling strip	41
5.1.6	Opening and closing the detector housing	41
5.2	Electrical installation	42
5.2.1	Cable screw unions	42
5.2.2	Installation cable requirements	42
5.2.3	Determination of the conductor cross-section for the power supply	42
5.2.4	Power supply	43
5.2.5	Reset input	44
5.2.6	Relay contacts	45
5.2.7	Open collector outputs	46
5.2.8	Connection to SecuriFire addressable loop with XLM 35 / ML-SFD	46
5.2.9	Installation of additional modules	47
5.2.10	Terminal assignments AMB 31, XLM 35 / ML-SFD and RIM 36	48
5.3	Sampling pipe	49
5.3.1	General	49
5.3.2	Mounting with PVC tubes and fittings	49
5.3.3	Mounting with ABS tubes and fittings	49
5.3.4	Mounting with metal pipes and fittings	49
5.3.5	Linear expansion	50
5.3.6	Mounting the sampling pipe (basics)	51
5.3.7	Creating the sampling holes	52
5.3.8	Mounting the sampling hole clips and maintenance clips	52
5.3.9	Mounting sampling stubs for a ceiling bushing	53
5.3.10	Types of mounting for equipment monitoring	54
5.4	Mounting dust filter unit, dust trap box, dust retaining box, water retaining box	56
6	Commissioning	57
6.1	Workflow overview	57
6.2	Opened detector housing	58
6.3	Step 0: Preparations	59
6.4	Step 1: Start device	59
6.5	Step 2: Parameterisation of the ASD 531	59
6.5.1	Setting detector sensitivity (BasiConfig)	60
6.5.2	Setting airflow monitoring and state latching	61
6.5.3	Quick guide	62
6.6	Step 3: Initial reset	63
6.7	Step 4: Function test	64
6.8	Commissioning protocol	65

Table of contents

7	Further functions	66
7.1	Reading the airflow	66
7.2	Isolate device	66
7.3	Filter monitoring	67
7.4	Logging off additional modules and the SD memory card	69
7.5	Switch device inactive	70
7.6	Reprogramming	71
7.6.1	Change to the detector sensitivity	71
7.6.2	Change to the sampling pipe	71
7.6.3	Changing the airflow monitoring setting	72
7.6.4	Changing the setting of the state latching and relay assignment on RIM 36	72
7.7	Uploading new firmware to the ASD 531	73
7.8	Setting the clock (RTC)	74
7.9	Expansion of the event memory	74
7.10	Reading and interpretation of events	75
7.10.1	ASD is operated without SD card	75
7.10.2	ASD was operated with SD card	75
7.10.3	Interpretation of the event data	75
7.11	Record and interpret log data	78
8	Indicators and operation	79
8.1	Indicators	79
8.2	Operation	80
8.3	Lamp test	80
8.4	Start filter replacement function	80
8.5	Operation from SecuriFire	80
9	Maintenance	81
9.1	Maintenance	81
9.1.1	Filter replacement on dust filter units	83
9.2	Replacement of components	84
9.2.1	Replacing the smoke sensor	84
9.2.2	Replacement of AFU 32 aspirating fan unit	85
9.2.3	Replacing the air flow sensor	86
9.2.4	Replacing the AMB 31 Main Board	86
10	Fault rectification	87
10.1	Fault events and their possible causes / rectification	87
11	Technical data	90
12	List of figures	91

1 Legal notice / Warnings

1.1 General



Notice

The rating plates, type designations and/or identifications on devices and printed circuit boards must not be removed, written over or defaced in any way.

1.2 Smoke sensors used



Notice

Only those smoke sensors in the device approval and in the list below may be used in the ASD 531 aspirating smoke detector. The use of third-party detectors voids the ASD 531 approval issued by the manufacturer.

1.3 Hardware / Firmware



Notice

The ASD 531 is to be operated only with the appropriate original firmware from the manufacturer.

Any unauthorised intervention in the firmware or the use of non-original firmware may result in malfunction and/or in damage to the device. Furthermore, all guarantee and warranty rights with respect to the manufacturer of the ASD 531 will become null and void as a result.

© Copyright by Securiton

All ASD 531 firmware is subject to the manufacturer's copyright. Any unauthorised intervention in the firmware, misuse, copying or unauthorised trade with the firmware represents a breach of copyright and will be subject to legal proceedings.



Notice

- A version change or extension of the ASD 531 firmware does not imply a right to an upgrade or new release for existing ASD 531 systems.
- We recommend using the most recent FW version. The manufacturer's specifications on hardware and firmware compatibility must be followed.



Warning

- Electronic components such as printed circuit boards are supplied in antistatic protective packaging. These components should be removed from the packaging just shortly before use or mounting.
- Only devices with unbroken or unopened seals (adhesive tape seal) are considered new. Packaging should not be opened until immediately before use.
- The cardboard packaging of the detector housing is can be stacked up to ten times its weight.
- The packages of the ASD 531 are suitable for post or rail shipment only to a limited extent.
- For transport in or to tropical regions, marine transport, etc., the appropriate measures must be taken (special packaging as provided by the shipper).

1.4 Planning



Notice

The use of special fire alarm systems such as the ASD 531 is subject in some cases to country-specific regulations and guidelines and must therefore be approved by the relevant technical bodies and authorities (insurance companies) prior to implementation.



Notice

For many uses that are country, facility and application specific there are planning guidelines, application examples and applicable regulations and directives.

These documents can be requested from the manufacturer of the ASD 531 system or from the responsible technical bodies and authorities.

1.5 Electrical installation



Danger

The electrical installation is to be carried out in accordance with the applicable country-specific regulations, standards and guidelines. Likewise, the local provisions must also be observed.



Danger

Make sure the power is disconnected for all connection and wiring work on the ASD 531.



Danger

The country-specific regulations and guidelines apply as a matter of principle to the intended use, planning and application of the ASD 531 aspirating smoke detector. In any case the country-specific specifications always take precedence over the planning specifications outlined below.



Danger

For safety reasons (EN 54) individual cables must be used for the outbound and return lines for addressable loop technologies.

Further, the manufacturer's specifications for the FACP concerning maximum line length, cable type, shielding etc. of the addressable loop technology must be observed.

The order separation and installation type are also subject to country-specific guidelines and regulations.



Notice

The electrical installation of the ASD 531 can normally be performed without screening. Screening of the installation is required wherever EMC influences are to be expected. In the following environments disturbance variables can be expected and the installation must be provided with screening accordingly:

In and around transmitter and radio facilities. Near high-voltage and low-voltage installations with high energy. In areas with EMC field intensities in excess of 10 V/m In cable ducts and vertical shafts together with high-energy cables In areas with high-energy devices and installations (generators, power plants, railway facilities, X-ray equipment, etc.). Outside buildings.

If screening is used, the cable screening in the ASD 531 is to be connected to an additional support terminal. The cable screening must **not** be connected to the minus or **ground** terminal of the AMB 31.



Notice

The conductor cross-section must always be determined and logged accordingly. Insufficiently rated conductor cross-sections can result in malfunctions of the aspirating smoke detector.



Notice

When connecting inductive consumers (e.g. relays), a free-wheeling diode is to be installed directly at the consumer, Fig. 29 .



Notice XLM 35 / ML-SFD installation

With the installation and use of an XLM 35 / ML-SFD, the ASD 531 meets the requirements in compliance with EN 54-17 (short-circuit isolation). To ensure that the required identification is recognisable in compliance with EN 54-17, the supplied identification sign must be easily visible outside on the ASD housing and attached in the immediate vicinity of the ASD rating plate (same side) when the XLM 35 / ML-SFD is installed.

1.6 Fire tests



Notice

If genuine fire tests are to be carried out, the relevant local authorities (fire service) are to be consulted be-forehand; the tests themselves are to be carried out by trained specialists (manufacturer) only.

1.7 Maintenance and service



Warning

Maintenance and service work on fire alarm systems are subject in part to country-specific laws and directives. Maintenance and service work may be performed only by persons trained and authorised by the manufacturer of the ASD 531. Depending on application, the ASD 531 must be serviced at least once a year by the manufacturer or by qualified personnel authorised and trained to do so by the manufacturer. If required (e.g. significant dirt hazard), the service interval is reduced to guarantee functional reliability. If filter boxes and/or dust filter units are used, the service life of the filter inserts play a role in the service interval. Depending on the level of dust and dirty in the object, filter service may vary greatly. The optimum filter service life is to be determined on site on a case by case basis. When using the filter monitoring as described in Sec. 7.3 the filter service life is set to 6 months by default, but it can be parameterised from 2 to 20 months. When using a DFU 911 dust filter unit, refer to Data Sheet T 140 705 for the application-specific specifications of the filter service life.



Warning

Aggressive cleaning agents (such as solvents, pure petrol or other alcohol-based agents) must not be used for cleaning.



Warning

Do not use compressed air either to blow out or open the smoke sensor. Improper handling can affect the response characteristics. Only the manufacturer is authorised to clean dirty smoke sensors. The smoke sensors are monitored for dust and dirt; their states are displayed on the control unit. If required the smoke sensor must be replaced.

Legal notice / Warnings



Warning

Blowing out from inside the smoke sensor chamber (through the fan) can damage the fan and is therefore not permitted.



Warning

Printed circuit boards are to be replaced or changed only by trained and qualified personnel. Handling is permissible only when the measures for protection against electrostatic discharge are observed and heeded.



Notice

Repairs to the device or parts thereof are to be carried out only by personnel trained by the manufacturer. Non-observance of this regulation results in the invalidation of warranty claims and the manufacturer's liability concerning the ASD 531.

All repairs and troubleshooting measures are to be documented.

The ASD 531 must undergo a function check following a repair or troubleshooting measure.

1.8 Environmental influences



Notice

The environmental conditions as described in Sec. 7.3 must be observed. Non-observance can negatively impact proper functioning of the ASD 531.



Notice

For special applications (e.g. in Arctic or tropical climates, in marine applications, high-level EMC environments, high shock impact, etc.) please contact the manufacturer of the ASD 531 for empirical values and special application guidelines.

1.9 Sampling pipe



Danger (see also Sec. 1.10.1)

As a material, PVC releases corrosive and toxic gases if burned or improperly disposed of. The use of PVC materials should therefore be restricted to wherever it is expressly permitted by the operator of the installation. In applications stipulated the use of halogen-free plastics, ABS or PA materials must be used for laying the sampling pipe. Country-specific guidelines and regulations must be observed.

The adhesives and cleaning agents used for connecting PVC and ABS materials contain solvents and are combustible. For this reason, prior to working with these materials it is imperative to read and observe the safety instructions and information provided by the adhesive supplier.





Warning – installation and modification of the sampling pipe

System performance depends on the sampling pipe. Any extensions or modifications to the installation may cause functional faults. The effects of such changes must be checked. It is very important to adhere to the specifications in Sec. 4 Planning bases. The "ASD PipeFlow" calculation software is available from the manufacturer

1.10 Disposal

The ASD 531 aspirating smoke detector and its packaging consist of recyclable material that can be disposed of as described in Sec. 1.10.1.

1.10.1 Materials used

Recycling

All raw materials and other materials used in the ASD 531 and all the technologies used in manufacturing are ecologically and environmentally friendly in compliance with ISO 14000.

All waste resulting from assembly (packaging and plastic parts) can be recycled and should be disposed of accordingly.

Devices, sampling pipes or parts thereof that are no longer used should be disposed of in an environmentally-friendly manner.

The manufacturer of the ASD 531 is obliged to take back any devices and sampling pipes that are defective or no longer used, for eco-friendly disposal. For this purpose the manufacturer has implemented a monitored and approved disposal system. This service is available worldwide at cost price.

Materials used in the ASD 531:

Detector housing	PC / ABS
Smoke sensor SSD 31	Lexan (PC)
Fan housing / fan wheel	PBTP / PBTP
Fan electric motor	PU / Cu / barium ferrite powder
Circuit boards, general	Epoxy resin hard paper
Soldering process	Environmentally-friendly manufacturing compliant with RoHS
Foil on control unit	PE
Sampling tubes	ABS / PA
Fittings	ABS / PA
Pipe clamps	PA
ABS adhesives	ABS / solvent MEK (methyl, ethyl, ketone)



Danger with PVC plastics

Because PVC plastics when burned produce toxic, corrosive and environmentally damaging combustion products, the use of PVC is not permitted in many applications. The relevant construction regulations must be observed.

Ecology:

PVC plastics cannot be manufactured and disposed of without environmental impact. The recycling of PVC is possible only up to a limited degree. Please refer to the danger notice above.

Sampling tubes	PVC, see danger notice above
Fittings	PVC, see danger notice above
PVC adhesives	PVC / solvent tetrahydrofurane, cyclohexanone

2 General

The ASD 531 aspirating smoke detector has the task of continuously taking air samples via a sampling pipe tube network from a monitored area and feeding the samples to a smoke sensor. Thanks to this detection method and the product's excellent properties under severe ambient conditions, the ASD 531 aspirating smoke detector is used wherever problems are to be expected owing to poorly accessible monitored areas or latent disturbance variables during operation such that optimal protection can no longer be guaranteed with conventional point detectors.

In contrast to point detectors, the ASD 531 has an extended alarm sensitivity range and additionally three pre-signal levels.

With the installation of the SecuriLine eXtended Module XLM 35 or the SecuriMultiLine module ML-SFD, the aspirating smoke detector ASD 531 can be ideally connected via the addressable loop to SecuriFire fire alarm systems.

These operating instructions include all the essential information for trouble-free operation. For obvious reasons, those details specific to individual countries or special applications can only be discussed if they are of general interest.

2.1 Uses and applications

- **Space surveillance:**
EDP rooms, ultra-clean rooms, warehouses, hollow floors, protection of cultural assets, transformer stations, prison cells, etc.
- **Equipment monitoring:**
EDP systems, electrical distributors, switch cabinets, etc.

The ASD 531 can also be deployed in areas where normally conventional point detectors are used. Local regulations and provisions must be observed from case to case.

The response behaviour of the ASD 531 has been tested in compliance with EN 54-20, Class A, B and C.

The ASD 531 can be connected via the relay contacts for alarm and fault to all common fire alarm systems with practically no restrictions.

2.2 Abbreviations and terms

The following abbreviations and terms are used in this document.

NO	= normally open
NC	= normally closed
COM	= common
ABS	= Acrylonitrile-butadiene styrene (plastic)
AI	= Alarm
ASD	= Aspirating Smoke Detector
ASD PipeFlow	= Calculation software for the sampling pipe, "ASD PipeFlow" as of Version 2.3
BasiConfig	= Commissioning without the "ASD PipeFlow" calculation software
EMC	= Electromagnetic compatibility
EN 54	= European standards for fire alarm systems (Germany = DIN, Switzerland = SN, Austria = Ö-Norm)
Ex-zone	= Area subject to explosion hazards
FACP	= Fire alarm control panel
FAS	= Fire alarm system
IEC	= International Electrotechnical Commission
Initial reset	= First start-up on commissioning
LS	= Airflow
LS-Ü	= Airflow monitoring
Manufacturer	= Securiton
OC	= Open collector output
PA	= Polyamide (plastic)
PC	= Polycarbonate (plastic)
PE	= Polyethylene (plastic)
PVC	= Polyvinyl chloride (plastic)
SSD 31	= Smoke sensor
St	= Fault
St-LS	= Airflow fault
UMS 35	= Universal Module Support
V-AI	= Pre-alarm
VDC	= Direct current voltage
VdS	= Verband der Schadenversicherer (Association of Indemnity Insurers, Germany)
VS	= Pre-signal

2.3 Product identification

For identification purposes, the ASD 531 and its units have rating plates or identification plates.

The following product identifications apply:

Rating plate on the ASD 531 and identification on the packaging

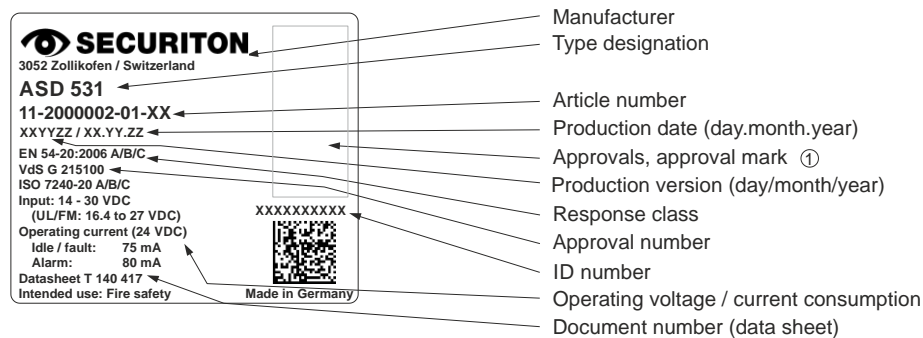

① Additional conformity marks may be affixed to a second rating plate or to an extended area of the rating plate (wider plate).

2.4 List of materials / components

2.4.1 Scope of Delivery

The ASD 531 is delivered with the following components.

- Complete detector housing, without options.
- Smoke sensor SSD 31 in protective packaging
- Mounting set, containing
3 x company plates, 2 x M20 blind plug, 4 x S6 dowels, 4 x Torx wood screws Ø 4.5 x 40 mm, 4 x M4 U-washers (Ø 4.3/12 x 1 mm)
- Commissioning protocol multilingual (en/de/fr/it)

2.4.2 Detector Housing Options

The detector housing can be extended with the following options

- SecuriLine eXtended-Modul XLM 35
- SecuriMultiLine module ML-SFD
- Relay Interface Module RIM 36
- SD memory card (industrial version)

2.4.3 Sampling pipe

The material for the sampling pipe can be purchased separately from the manufacturer in the required quantities, based on the size and use of the system. See also Sec. 3.5

2.5 Packaging

The detector housing is delivered in a customised cardboard sleeve sealed with adhesive tape. The packaging is recyclable and can be reused.

The mounting set and installation material sundries are packed in recyclable bags. The sampling tube is supplied in sections (approx. 5 m). The flexible tube is supplied in 50 m rolls.

The contents of the packaging are specified as described in Sec. 2.3.

2.6 Tools for handling the detector housing

The tools listed below are required for mounting and installation

Opening the detector housing	flat-blade screwdriver No. 5 (8 mm)
Removing the pipe plug	flat-blade screwdriver No. 2 (4 mm)
Securing the detector housing	Torx screwdriver T20
Module holder for additional modules	Torx screwdriver T15
Terminals	no. 1 flat-blade screwdriver (3.5 mm)
Replacing printed circuit board AMB	Torx screwdriver T10
Replacing the aspirating fan unit	Torx screwdriver T15

2.7 Document Index

Data sheet ASD 531	T 140 417
Material for the sampling pipe	T 140 416
Commissioning protocol	T 140 418
Data sheets XLM 35	T 140 088
Data sheets ML-SFD	T 140 822
Data sheets RIM 36	T 140 364
AFU 32 Aspirating Fan Unit mounting instructions	T 140 426

3 Design and function

3.1 Block diagram of device with explanation of the basic functions

In the sampling pipe tube network, the fan generates a vacuum which results in fresh air continuously reaching the detector housing via the sampling pipe. In this way the smoke sensor is constantly supplied with new air samples from the monitored area. Should the smoke concentration exceed the permissible value, the ASD 531 triggers an alarm and displays it optically. The alarm is relayed to a superordinate fire alarm control panel via potential-free change-over contacts or via SecuriFire addressable loop module.

The operational reliability of the aspirating smoke detector depends on the functional reliability of the smoke sensor and on the constant air supply to the system. Fan failure, pipe blockage of the sampling holes or pipe breakage must be communicated to the fire alarm control panel in the form of a fault signal.. This condition is satisfied by the airflow monitoring of the ASD 531.

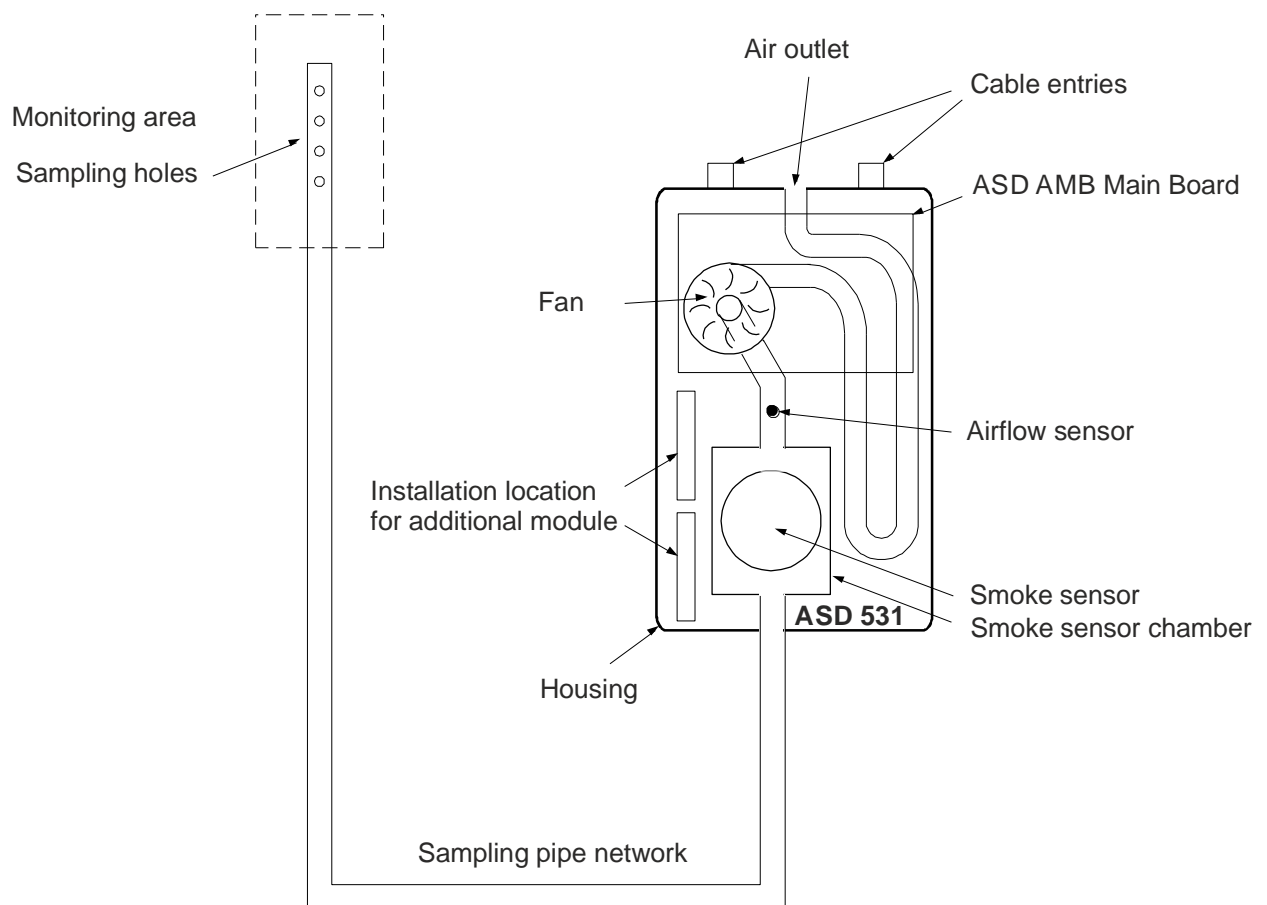

Fig. 1 Design

3.1.1 Power supply

The operating voltage of the ASD 531 is 24VDC (range +14 to +30 VDC, UL/FM = 16.5 to 27 VDC). If the operating voltage falls below 13 VDC, the ASD 531 triggers a fault.

3.1.2 Fan control

The aspirating smoke detector ASD 531 has a constant pre-defined fan speed of 5250 rpm.

Any blocking of the fan is detected by evaluating the motor speed. If the specified threshold is undershot, the fan supply is switched off and a fault is signalled.

3.1.3 Indicators

The following events are indicated by LEDs on the control unit:

- Operation, alarm, pre-signal 1, pre-signal 2, pre-signal 3, fault, detector dusty, detector dirty

Depending on the event, the LEDs are continuously lit or flash with different frequencies (see Sec. 8.1).

3.1.4 Rotary switch "Mode" switch positions

The switch positions and their function are listed below:

- Pos. 0 Initial reset (see Sec.6.6)
- Pos. 1 Operation position
- Pos. 2 Isolate device (see Sec.7.2)
- Pos. 3 Test pre-signal (see Sec.7.6.4/4)
- Pos. 4 Test alarm signal (see Sec.7.6.4/4)
- Pos. 5 Test fault signal (see Sec.7.6.4/4)
- Pos. 6 Log off optional module (see Sec.7.4)
- Pos. 7 Device inactive (see Sec.7.5)
- Pos. 8 Filter monitoring On/Off, filter replacement (see Sec.7.3)
- Pos. 9 Read out / change filter service life (see Sec.7.3)
- Pos. A to F Reserve

When the "Mode" rotary switch is turned to a new position, it must be confirmed within 5 s with the "Set/Res" key. If not, an-other 5 s delay time occurs ("Mode" LED flashes). If no confirmation occurs after this time, the ASD triggers a rotary switch fault.

3.1.5 Relay

The ASD 531 has several relays with potential-free change-over contacts (see Sec. 5.2.6).

Main board AMB 31

- Alarm
- Fault (all faults and ASD inactive)

Relay Interface Module RIM 36 (optional)

Default assignment

- Pre-signal 1 (30% of alarm threshold)
- Pre-signal 2 (50% of alarm threshold)
- Pre-signal 3 (70% of alarm threshold)
- Smoke sensor dusty/soiling/fault
- Sampling tube breakage/blockage, fan fault.

Alternative assignment

- Alarm
- Fault¹⁾
- Alarm or fault¹⁾

¹⁾ all faults except ASD inactive

3.1.6 Outputs

There are two open collector outputs (OC 1 and OC 2) on the ASD 531. Parallel indicators, feedback indicators or other consumers (e.g. relays) can be connected to these outputs. (see also Sec. 5.2.6).

Main board AMB 31

- Alarm
- Fault (all faults and ASD inactive)

3.1.7 Input

The ASD 531 has an "External reset", input used to reset the device to its normal state after an event.

When a continuous signal is applied for more than 20 s, the ASD 531 is switched inactive.

(see also Sec. 5.2.5).

3.1.8 Interfaces

Main board AMB 31

- SD memory card (recording of operating data, updating of firmware, setting clock)

Interface module XLM 35 / ML-SFD (optional)

- SecuriLine eXtended / SecuriMultiLine (SecurFire addressable loop)

3.1.9 Airflow monitoring

An airflow sensor is installed in the detector housing in such a way that any change in the sampling pipe (pipe breakage, pipe blockage) can be evaluated.

The current airflow can be read at the LED bar on the AMB 31.

3.1.10 Alarm release

If the set limits (alarm, pre-signals 1-3) are exceeded, the corresponding state "**Alarm**", "**Pre-signal 1/2/3**" is triggered on the ASD 531.

3.1.11 Fault triggering

If a fault occurs on the ASD 531, the "Fault" relay is inactive and the "Fault" display is activated.

The time and type of fault can be read using the event memory.

(see Sec.7.10).

The following events trigger a fault (list is incomplete):

- Fault: airflow (after expiry of **LS** delay time)
- Fault: fan (fan limit data exceeded or fallen short of, tacho signal)
- Initial reset fault
- Fault: smoke sensor soiled
- Fault: smoke sensor missing; communication disrupted; other
- AMB 31 communication fault to XLM 35 / ML-SFD / RIM 36 (individual)
- Emergency fault (microcontroller failure)
- Undervoltage fault
- Supply fault (no voltage on the ASD, without "Fault" display)
- ASD inactive via "External reset" input.

3.1.12 Event memory

The ASD 531 has an internal event memory for the last 1000 events. The event memory cannot be deleted. The event memory can be read out via an SD memory card.

Using an SD memory card (Option), the memory can be extended by up to 640,000 events.

(see also Sec.7.9 and 7.10).

3.1.13 State reset

The ASD 531 can be reset after a triggered event by

- Pressing the "Reset" key on the ASD
- Briefly actuating the "External reset" input.
- Command via XLM 35 / ML-SFD (Option)

An event is only reset if it is no longer active.

As a result of the state reset, the ASD 531 continues to run "normally" and the fan does not stop.

3.1.14 Hardware reset

A hardware reset is triggered if there is an interruption of the supply voltage or if the "HW reset" key is pressed on the AMB 31 (see Sec. 3.3.1). This restarts the ASD 531. The fan stops and then slowly starts up again (start-up control).



Notice

Attention: fire incident control, remote alerting !!

A hardware reset briefly triggers the fault relay (approx. 1 s). So before maintenance work is carried out on the ASD 531, it is essential to switch off the fire incident controls and remote alerting on superordinate systems (FACP).

3.1.15 Initial reset

The initial reset is triggered by the switch pos. 0 and confirming with the "Set/Reset" key.

The initial reset is used to record the airflow values and to adjust the airflow monitoring to the connected sampling pipe.

The LS reference values remain stored until such time as another initial reset is carried out.

When commissioning the ASD 531, it is necessary to perform an initial reset to automatically adjusting the airflow monitoring on the connected sampling pipe.

Other situations can also necessitate an initial reset:

- After an extension, upgrade or repair to the sampling pipe
- After a repair to the ASD 531, when replacing the fan, the airflow sensor or the AMB 31 main circuit board
- In the case of an FW upgrade, only if expressly mentioned in the relevant firmware description

3.1.16 Configuration

To aid commissioning of the ASD 531, there are three rotary switches and two DIP switches inside the device on the AMB 31 [Main Board](#)

These elements are used when commissioning the ASD 531. Device settings for pre-defined system limits can be called up. These pre-defined positions are stored with normative values for response sensitivity, airflow monitoring (LS-Ü) and pipe configuration. They also contain positions which allow deviations from the normative limits with regard to airflow monitoring.

3.2 Mechanical design

The ASD 531 aspirating smoke detector consists of the detector housing and a sampling pipe tube network. The sampling pipe is made of hard PVC or ABS tubes with an external diameter of 25 mm and an internal diameter of 20 mm (see also Sec. 5.3.1). In special applications – e.g. extremely corrosive environment – other tube materials can also be used, subject to the specifications set out in Sec. 5.3.1.

The sampling pipe has several sampling holes whose size is such that each hole extracts the same amount of air from the monitored area. The sampling pipe may be I-, U-, T-, H-, or E-shaped. The sampling pipe is symmetrically designed in principle. Asymmetrical sampling pipe tube networks can also be implemented with the help of the “ASD PipeFlow” calculation software.

The housing cover on the detector housing is opened by means of four rotary snap locks.

Integrated in the detector housing is a fan which, in conjunction with the sampling pipe, ensures an uninterrupted supply of air to the detector housing. Airflow monitoring detects any pipe blockages and pipe breakages in the sampling pipe.

There is one chamber for the smoke sensor in the detector housing. The air channel through the smoke sensor and fan are separated from the other parts inside the detector housing; this means the ASD 531 is able to remain fully operational during commissioning and maintenance work even when the housing cover is open.

The AMB 31 [Main Board](#) contains the processor-controlled evaluation electronics and the connection technology.

There are two slots in the detector housing for installing optional expansion modules (XLM 35 / ML-SFD, RIM 36).

Pre-defined labelling strips are used for labelling the control unit in the housing cover. If the device is mounted in a position rotated by 180°, the labelling strip can be turned accordingly.

Bottom part of detector housing

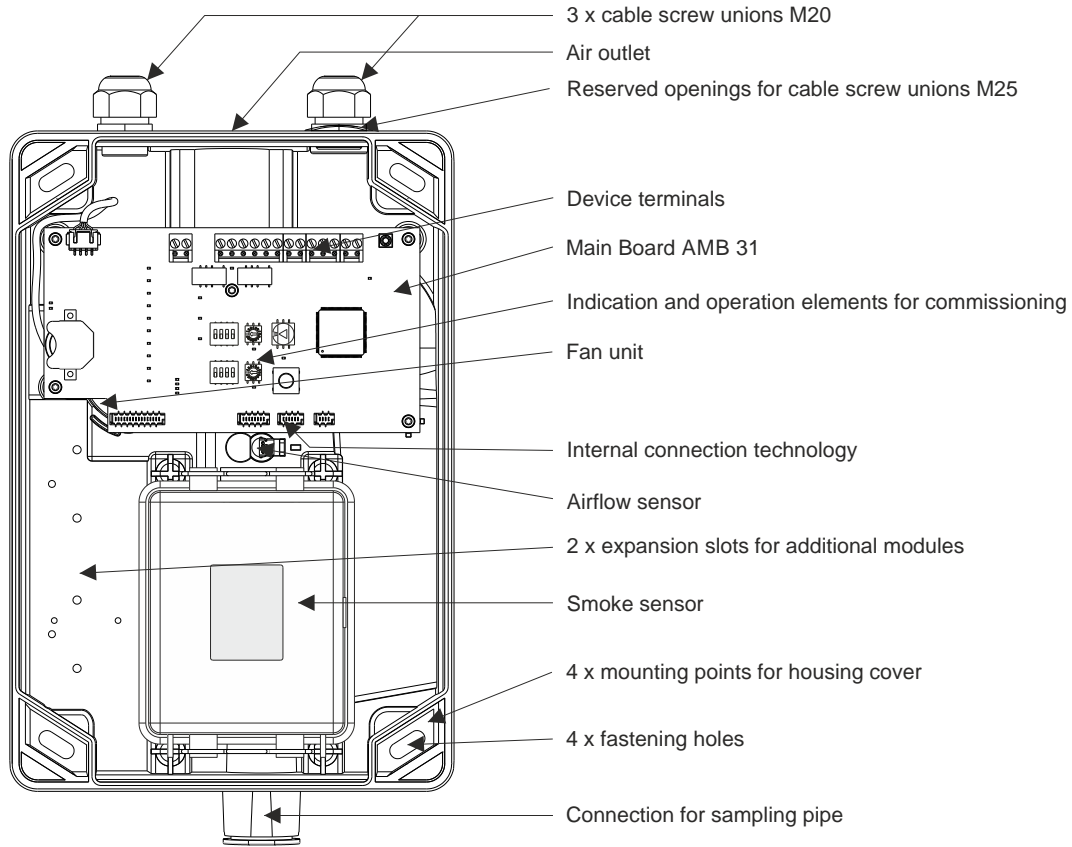

Housing cover

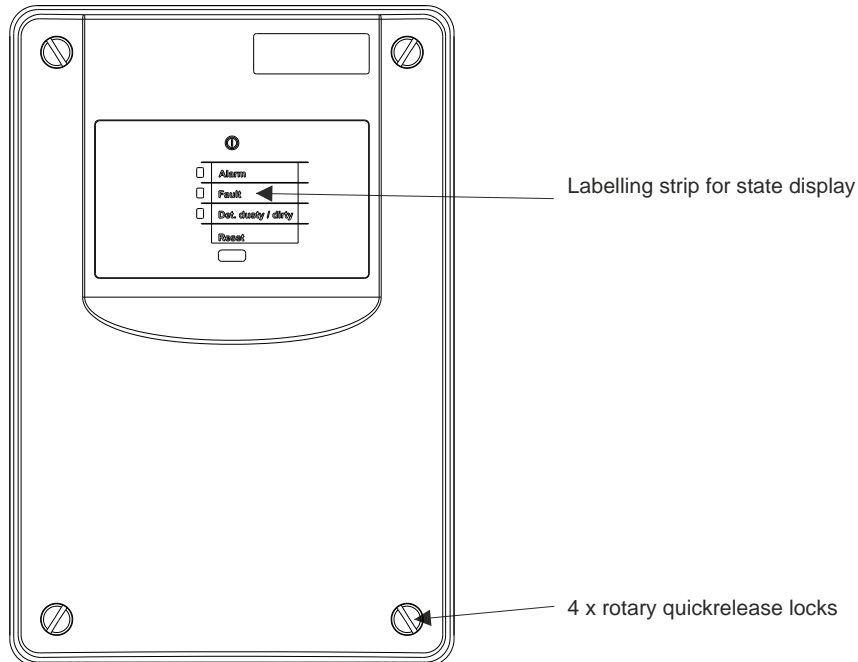

Fig. 2 Mechanical design

3.3 Electrical design

The ASD 531 contains the following electrical elements:

- Main Board (AMB 31)
- Smoke sensor (SSD 31)
- Fans (AFU 32)
- Airflow sensor (AFS 32)
- Optional extension modules (XLM 35 / ML-SFD, RIM 36, SD memory card)

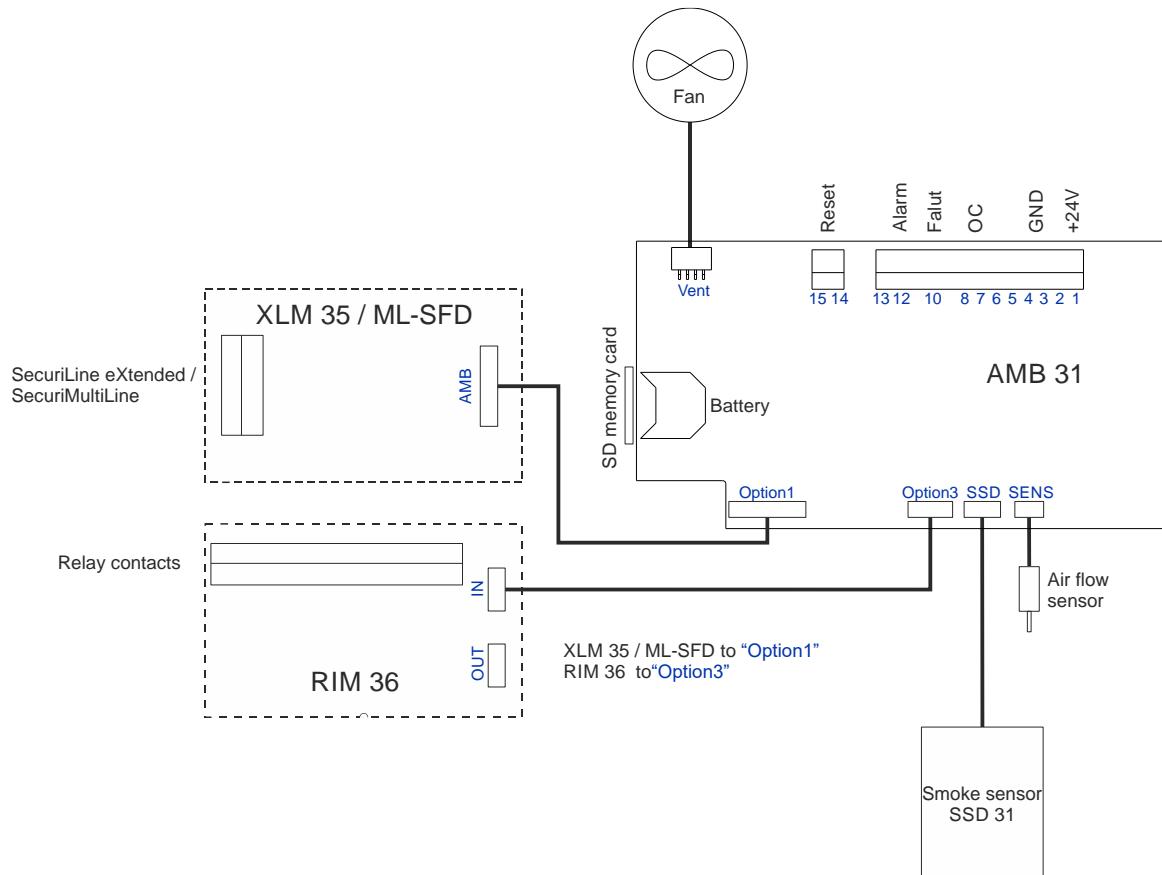

Fig. 3 Block diagram

3.3.1 AMB 31 Main Board

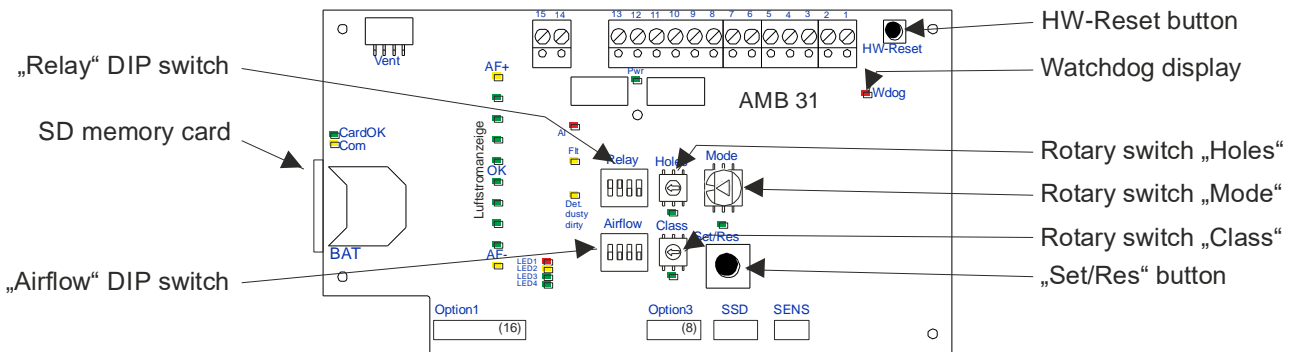

Fig. 4 AMB 31

The following circuit components and elements are on the AMB 31 Main Board:

- Fan control with airflow evaluation and temperature measurement
- Smoke sensor evaluation
- Lithium battery
- RTC clock
- 3 rotary switches and 2 DIP switches for configuration setting
- 4 LEDs for displaying operation, alarm, fault, dust and soiling
- 2 relays with potential-free change-over contacts for fault, alarm
- Terminal blocks with pluggable screw terminals for the device connection
- SD memory card holder
- 1 x 16-pin ribbon cable connector (**Option1**) for connecting to the XLM 35 / ML-SFD
- 1 x 8-pin ribbon cable connector (**Option3**) for connecting to the RIM 36
- One 6-pin ribbon cable connector for connecting to the smoke sensor
- One 4-pin plug for connecting to the air flow sensor
- Hardware reset key

Indicators on the AMB 31 Main Board AMB

Various LEDs with the following meaning are present on the AMB 31 Main Board (see also 8.1):

- LED "Class" and "Holes" flash = invalid constellation of rotary switches "Class" and "Holes";
- LED "Mode" = various functions (see Sec. 0);
- LED "WDog" = watchdog display (processor not running → ASD has triggered a fault);
- LED "CardOK" = SD memory card present;
- LED "Com" = communication with the SD memory card.
- LED "AF+ / OK / AF-" = current airflow value
- LED 2 (yellow) flashes = Filter replacement started
- LED 4 (green) is lit = Filter monitoring "On"

3.4 Optional accessories (internal) XLM / ML-SFD, RIM, SD card

3.4.1 XLM 35 SecuriLine eXtended Line Module

The XLM 35 is an extension module for connecting the ASD 531 to the addressable loop SecuriLine eXtended Line of the SecuriFire fire alarm system.

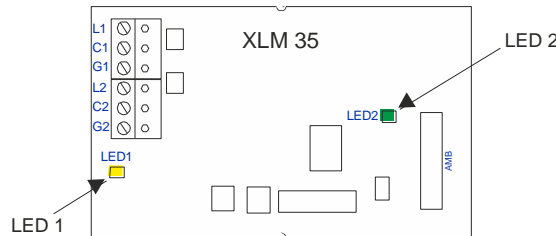

Fig. 5 XLM 35

The two LEDs on the **XLM 35** indicate the communication state.

Both LEDs flash in normal operation.

Further information on XLM 35

- Sec. 5.2.8 Connection to SecuriFire addressable loop with XLM 35 / ML-SFD
- Sec. 5.2.9 Installation of additional modules
- Sec. 5.2.10 Terminal assignments AMB 31, XLM 35 / ML-SFD and RIM 36
- T 140 088 Data sheet XLM 35

3.4.2 ML-SFD SecuriMultiLine-Module

The ML-SFD is an extension module for connecting the ASD 531 to the addressable loop SecuriMultiLine of the SecuriFire fire alarm system. The ML-SFD is expected to be available with the SecuriFire Release Package SRP3.1.

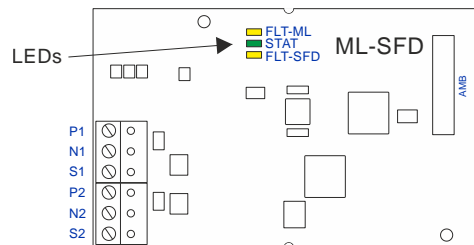

Fig. 6 ML-SFD

The three LEDs on the **ML-SFD** indicate the communication state.

In normal operation, the green LED (STAT) lights up continuously, the two yellow LEDs do not light up.

Further information on ML-SFD

- Sec. 5.2.8 Connection to SecuriFire addressable loop with XLM 35 / ML-SFD
- Sec. 5.2.9 Installation of additional modules
- Sec. 5.2.10 Terminal assignments AMB 31, XLM 35 / ML-SFD and RIM 36
- T 140 822 Data sheet SF-SFD

3.4.3 RIM 36 Relay Interface Module with 5 relays

The RIM 36 is an expansion module and has 5 relays with potential-free change-over contacts.

Default assignment

- Pre-signal 1 (30% of alarm threshold)
- Pre-signal 2 (50% of alarm threshold)
- Pre-signal 3 (70% of alarm threshold)
- Smoke sensor dusty/soiling/fault
- Sampling tube breakage/blockage, fan fault.

Alternative assignment

- Alarm
- Fault¹⁾
- Alarm or fault¹⁾

¹⁾ all faults except ASD inactive

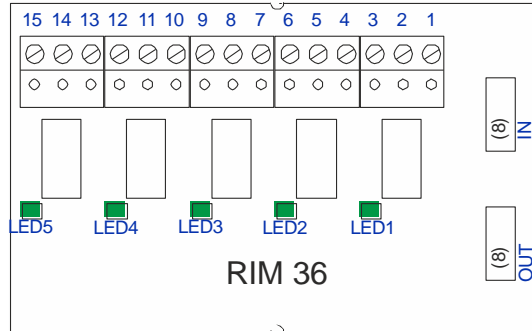

Fig. 7 RIM 36

Further information on RIM 36

Sec. 5.2.6 Relay contacts

Sec. 5.2.9 Installation of additional modules

Sec. 5.2.10 Terminal assignments AMB 31, XLM 35 / ML-SFD and RIM 36

T 140 364 Data sheet RIM 36

3.4.4 SD memory card

The **SD memory card** is automatically detected when the device is switched on and when the card is inserted. From then on it is monitored. Data logging begins automatically after approx. 10 s. The associated LEDs "**CardOk**" and "**Com**" (communication with the **SD memory card**) are activated accordingly on the AMB 31.

Functions of the **SD memory card**:

- Extension of the event memory (see Sec. 3.1.12 and 7.9)
- Record and interpret log data (see Sec. 7.11)
- Load new firmware onto ASD 531 (see Sec. 7.7)
- Setting the clock (see Sec. 7.8)

Notices:

- Only industrial SD memory cards tested and approved by the manufacturer may be used. The use of a consumer SD memory card is to be avoided – this can lead to data loss or destruction of the SD memory card and faults on the ASD.
- Before using the SD memory card, make sure it is blank.
- The **SD memory card** is inserted with the contact side facing towards the LMB circuit board and pushed into the holder until it snaps into place. Pressing the **SD memory card** again releases the locking mechanism and the **SD memory card** can then be removed from the holder
- To avoid data loss, log off the SD memory card on the AMB 31 (Mode rotary switch, position 6) before removing (see Sec. 7.4).

3.5 Optional accessories (external), filters etc.

3.5.1 Sampling pipe

If the sampling pipe is being used in extremely corrosive environments, provide for sufficiently resistant tube materials. Please contact the manufacturer of the ASD 531 for the material specifications.

3.5.2 Use under extreme conditions

Applications with extremely high levels of dust and/or dirt, extreme temperature ranges and/or atmospheric humidity outside the specified limit values require the use of accessory parts as instructed by the manufacturer, e.g.:

- Dust filter unit
- Dirt trap box
- Dust retaining box
- Water retaining box
- Manual ball valve for sporadic cleaning of the sampling pipe using compressed air
- Automatic blow-out device
- Insulation of the sampling pipe
- Use of cooling sections in the sampling pipe



Notice

Operation and application under extreme conditions may be implemented only after consulting with the manufacturer and under his supervision.

When using the above listed accessory parts, it is necessary to perform a sampling pipe calculation with "ASD PipeFlow" (see Sec. 4.2.1 for exceptions).

The initial reset during commissioning must be carried out with the built in accessory parts.

If an accessory part is subsequently deployed in an already installed ASD 531, a new initial reset must be carried out.

Further information

- Sec.5.4 Mounting dust filter unit, dust trap box, dust retaining box, water retaining box.
- The complete overview of the available accessory parts can be found in the product catalogue ASD 531.
- "Filter monitoring" function, Chap. 7.3

4 Planning bases

The ASD 531 aspirating smoke detector complies with the requirements of European standard EN 54-20, class A to C. The following applies:

- EN 54-20, class A high sensitive
- EN 54-20, class B sensitive
- EN 54-20, class C standard

4.1 System limits

When the ASD 531 aspirating smoke detector is used, the system limits below pertain, which meet EN 54-20 requirements. In addition to these, the system limits for equipment monitoring in accordance with Sec. 4.3.5 must be observed.

		Class A	Class B	Class C
Overall length of the sampling pipe tube network (incl. any air recirculation)	max.	with PipeFlow 75m/with BasiConfig 55 m		
Length from ASD to farthest sampling hole	max.	with PipeFlow 40m/with BasiConfig 30 m		
Number of sampling holes total	max.	6	8	12

4.2 BasiConfig or ASD PipeFlow?

This chapter provides the basis for decision on the project planning process using BasiConfig or ASD PipeFlow.

4.2.1 BasiConfig

BasiConfig was specially developed to quickly plan projects in a straightforward way without using PC software. The "response sensitivity" and "number of sampling points" parameters are programmed directly on the ASD using "Class" & "Holes" rotary switches.

BasiConfig can be used (advisable) for ASD 531 installations in which all of the following properties may apply:

- Symmetrical sampling pipe tube network (max 10% of the asymmetry). This applies to tube layout as well as the spacing of sampling holes.
- A maximum of one DFU 911 dust filter unit and one water retaining box (WRB) can be used in the tube network.
- Max. of two 90° angles
- No air recirculation
- Exclusive use of tube materials with a diameter of 25 mm, including flexible hose with a diameter of 25 mm

There are no restrictions in use (space surveillance, high-rack storage, false ceilings, etc.) as long as the criteria specified above are fulfilled.

4.2.2 PipeFlow

The use of the PC software ASD PipeFlow is essential for ASD 531 installations with one or more of the following properties:

- Asymmetrical sampling pipe tube network
- Use of extra equipment
- More than two 90° angles
- Use with air recirculation
- Use of tube materials with a diameter of \neq 25 mm, including flexible hose with a diameter of \neq 25 mm

4.2.2.1 ASD PipeFlow short description

The “ASD PipeFlow” calculation software is used for planning the sampling pipe tube network. Its purpose is to design on a drawing the pipe layouts required for implementing a system and assign the sampling holes. The “ASD PipeFlow” calculation software provides a selection of different tube materials, fittings and accessory parts (filter-boxes, water retaining boxes, etc.). The end result of the calculation software specifies the parameters required for a standard-compliant trigger in accordance with EN 54-20, class A to C, after which the parameters are programmed on the ASD 531.

Asymmetrical sampling pipe tube networks can also be planned and set up using the “ASD PipeFlow” calculation software. The system limits for an EN 54-20-compliant trigger are defined in the calculation software.

The material stored in the “ASD PipeFlow” calculation software for the sampling pipe – and the “ASD PipeFlow” calculation software itself – are an integral part of the VdS device approval. A list of the available materials for the sampling pipe is provided in a separate document (T 131 194).

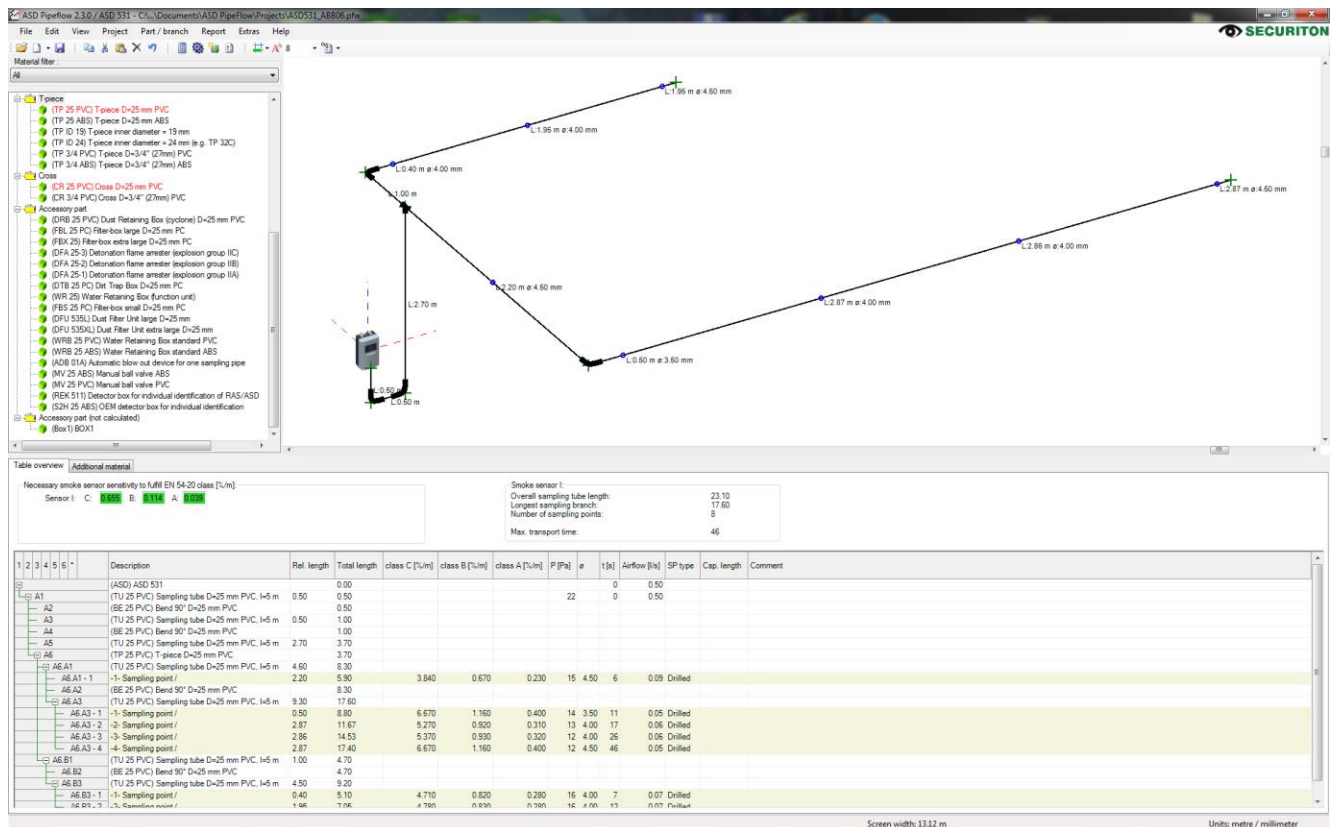

Fig. 8 "ASD PipeFlow" program interface

4.2.2.2 Ensuring a minimum airflow

When planning with “ASD PipeFlow”, it is necessary to check that the volume airflow is at least 0.1 l/s (indicated in “ASD PipeFlow” > “Table view” > Row “(ASD) ASD 531”). For very short pipe systems with 1 or 2 sampling holes, it may happen that “ASD PipeFlow” suggests small sampling holes in range of 2.0 / 2.5 mm diameter so that the volume airflow is less than 0.1 l/s. In this case, select sampling holes in the pipe system that are bigger (see Sec. 4.3.6). The result requires a new “calculate” (not “optimise”) in “ASD PipeFlow” with these larger sampling holes, and the suggested response sensitivity must be programmed in ASD 531.

4.3 Space surveillance applications

4.3.1 Examples of application

- Spaces where point detectors are difficult to mount due to poor accessibility, e.g.:
 - Cable galleries, cable tunnels, false ceilings, hollow floors
 - Machine halls, production halls
 - Low- and high-voltage rooms
 - Computer rooms, clean rooms
- In spaces where, for aesthetic reasons, point detectors may not be mounted, for example:
 - Protection of cultural assets
 - Museums
- In areas where point detectors may be damaged, for example:
 - Prison cells
 - Public passageways.
- Spaces with localised smoke development, e.g.:
 - warehouses with diesel forklifts
- Spaces with a high level of dust pollution and/or high atmospheric humidity.



Notice

Applications with a high level of dust and/or high atmospheric humidity require the use of accessory parts as recommended by the manufacturer, e.g.: Dust filter unit, dust trap box, water retaining box or three-way tap for sporadic cleaning of the sampling pipe with compressed air (see also Sec. 5.4)

4.3.2 Principles of space surveillance

In general the monitoring areas are the same as for point-type smoke detectors. Directives that apply to specific objects (e.g. prison cells) must be observed.

Changes of direction in the tube network increase the detection time.

90° bends are to be used instead of 90° angles. When planning **without** "ASD PipeFlow" calculation, do not use more than **a maximum of two 90° angles**. Other necessary changes of direction in the sampling pipe are implemented with 90° bends.

4.3.3 Maintenance sampling hole

In applications with sampling holes that are difficult to access, a maintenance sampling hole can be made immediately after the detector housing in the sampling pipe if necessary. The maintenance sampling hole must be drilled with a hole diameter of 3.5 mm. The distance from the detector housing must be at least 0.5 m.

If required, the maintenance sampling hole can be made using the special "maintenance clip" (clip without drilling). See also Sec. 5.3.8.

When making a maintenance sampling hole, observe the following principles:

A maintenance sampling hole should be made only if required, for example where normal sampling holes are difficult to access.

A maintenance sampling hole is not included in the calculations as per Sec. 4.1.

The maintenance sampling hole is used only for maintenance purposes, to test the ASD 531 for alarming.

In normal operation (no maintenance), the maintenance sampling hole must be sealed off with adhesive tape or a "maintenance clip" if available.

All commissioning work on the airflow monitoring (initial reset) must be carried out with the maintenance sampling hole sealed off.

4.3.4 Symmetrical tube networks (with BasiConfig or ASD PipeFlow)

As a basis for decision on the project planning process, see Sec. 4.2 "BasiConfig or ASD PipeFlow?".

4.3.5 Tube topologies with system limits

With ASD PipeFlow

Any topologies can be implemented.

The limits based on the response grades according to Sec. 4.1 System limits must always be observed.

With ASD BasiConfig

Fig. 9 below shows all possible sampling pipe tube network topologies with the maximum tube lengths and number of sampling holes.

The limits based on the response grades according to Sec. 4.1 System limits must always be observed.

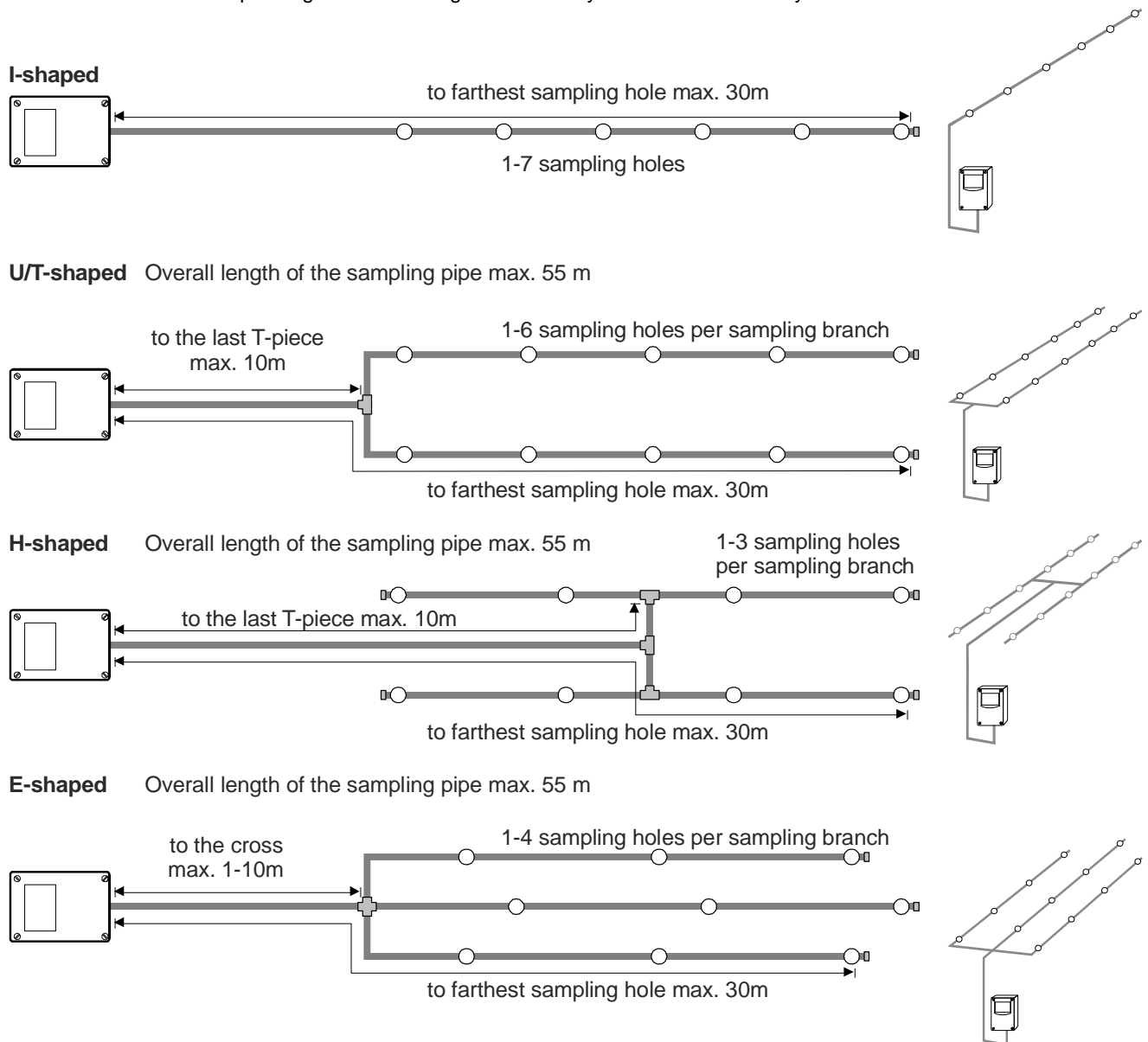

Fig. 9 Sampling pipe definitions

4.3.6 Hole diameter increment

To ensure that all the sampling holes take in the same amount of air, the diameter of the sampling hole on the sampling tubes fitted must increase as the distance from the detector housing increases, depending on the number of sampling holes per sampling branch.

If required, the sampling holes can be created using the special "sampling hole clips". The sampling hole clips are available in various sizes (i.e. with hole diameters: 2.0/2.5/3.0/3.5/4.0/4.5/5.5/6/6.5/7 mm). See also Sec. 5.3.8

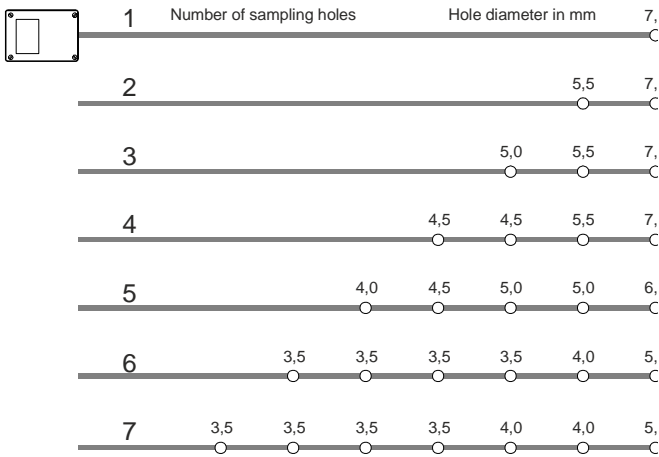

Fig. 10 Size of sampling holes (I-shaped)

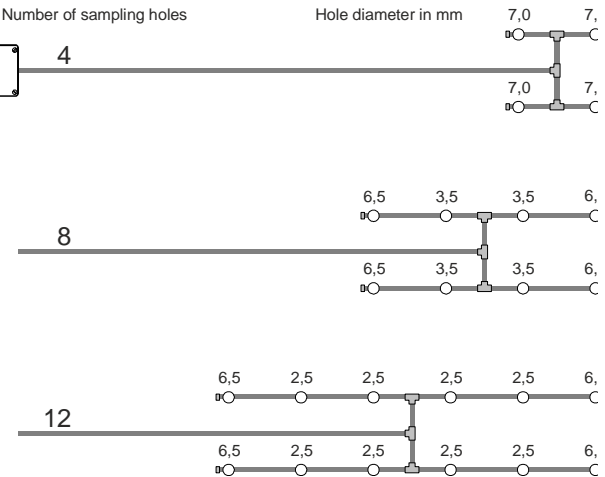

Fig. 11 Size of sampling holes (H-shaped)

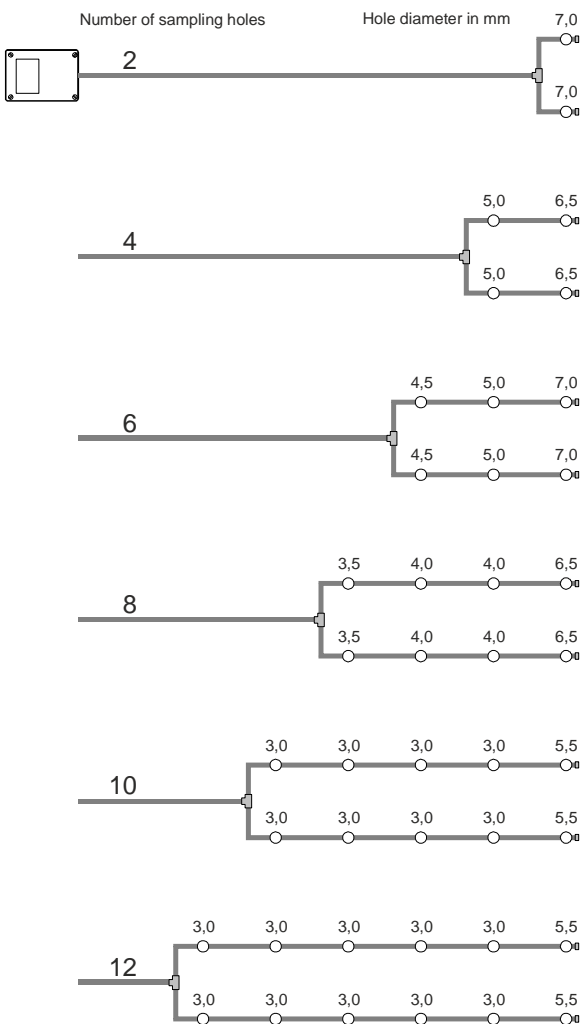

Fig. 12 Size of sampling holes (U/T-shaped)

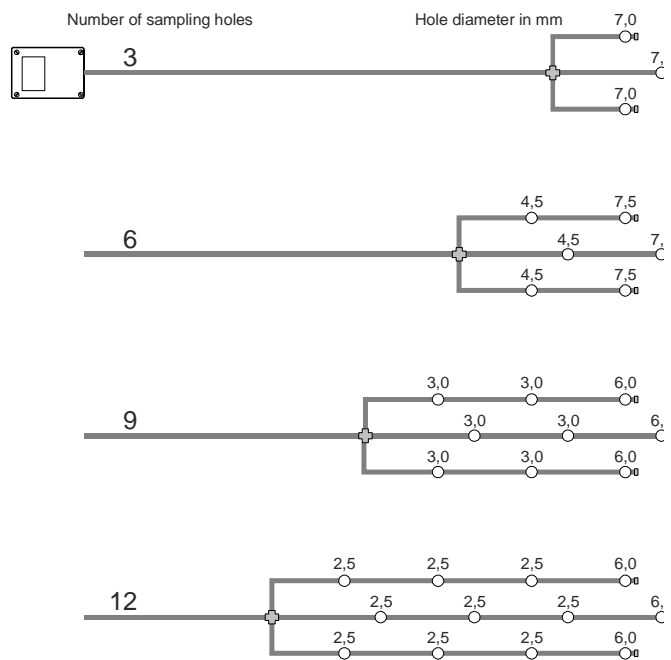

Fig. 13 Size of sampling holes (E-shaped)

4.3.7 Asymmetrical tube networks (only with ASD PipeFlow)

Planning must be performed with the "ASD PipeFlow" calculation software.

4.3.8 Example of asymmetrical tube network

Space surveillance

Typical layout types for space surveillance are I-shaped, U-shaped, T-shaped, H-shaped and E-shaped sampling pipe tube networks. Other network layout shapes can also be planned using the "ASD PipeFlow" calculation software.

Irregular spacing of sampling holes as well as sampling holes in front of the T-piece/cross are also possible when planning with "ASD PipeFlow" calculation.

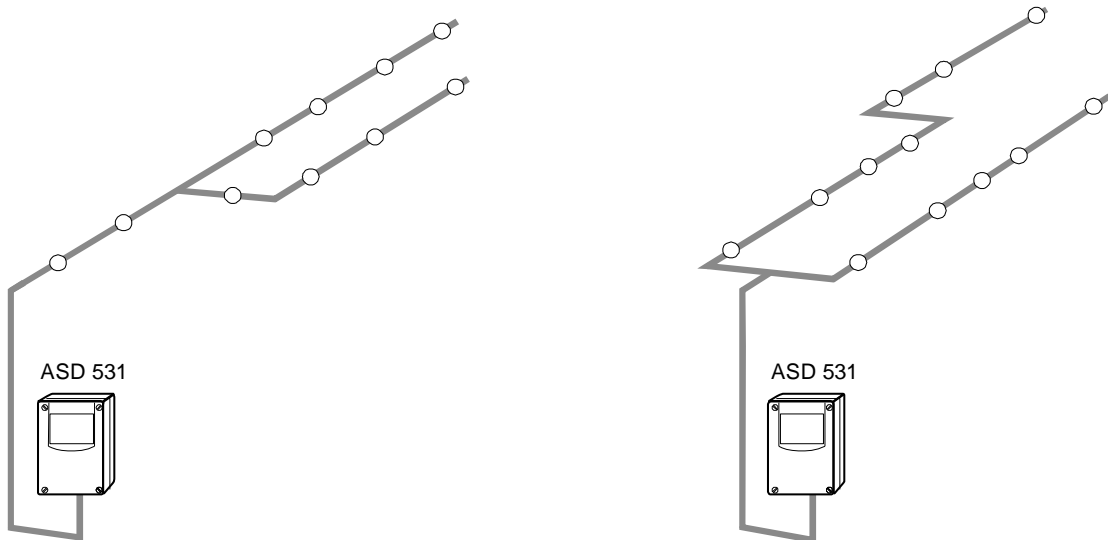

Fig. 14 Examples of planning with "ASD PipeFlow" calculation

4.4 Equipment monitoring applications (only with ASD PipeFlow)

Equipment monitoring involves monitoring an object directly (machine, device or equipment).

4.4.1 Examples of application

- Electrics cabinets with or without forced ventilation
- EDP computer systems and EDP cabinets with or without ventilation
- Devices and machines in production technology
- Transmitting installations/transmission facilities
- Vacuum cupboards in the chemical industry (air recirculation), subject to prior consultation with the manufacturer

4.4.2 Basics

Symmetry does not have to be observed for equipment monitoring. This also applies to the sampling pipe and the sampling fixtures.

For equipment monitoring, it is preferable to use classes A and B compliant with EN 54-20.

Planning must be performed with the **“ASD PipeFlow” calculation software.**

In contrast to space surveillance, where individual sampling holes are used, the equipment monitoring sampling devices use several sampling holes.

The limits based on the response grades according to Sec. 4.1 System limits must always be observed.

The sampling fixture is defined as a small pipe entity in the shape of an "I", "U", "T", "H" or other form with typically two to four sampling holes.

The sampling fixtures are arranged relative to the object so that they take in the outflowing air (ventilation slot or screen). Ideally the sampling holes are distributed symmetrically on each sampling fixture over the surface of the opening/screen.

On objects with a high airflow rate (strong ventilation), the sampling holes can be fitted with funnels for optimal smoke detection.

Types of sampling pipe layouts

Pipe line through hollow floor

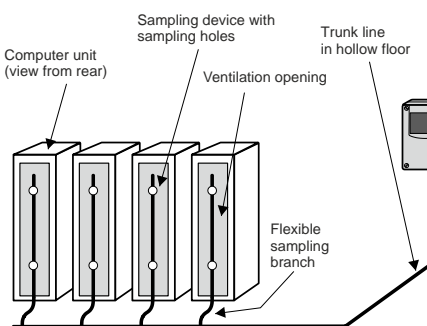

Pipe line through wall or ceiling

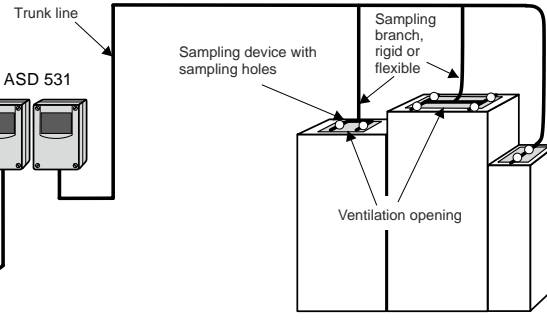

Direct mounting on ventilated EDP cabinets

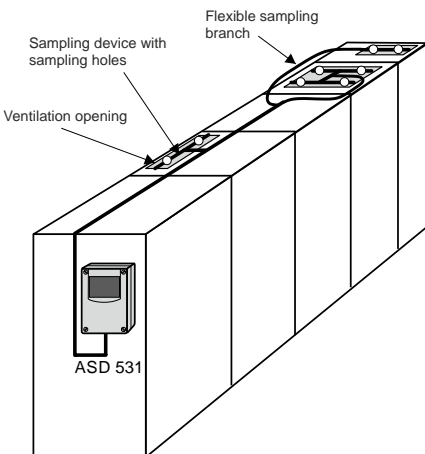

Direct mounting on electrical cabinets without ventilation

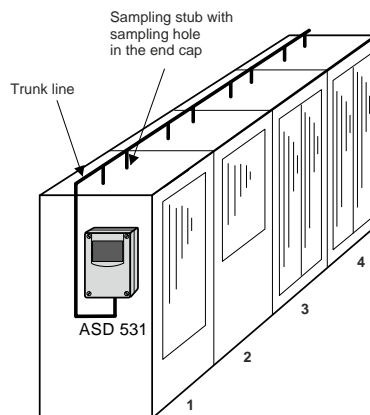

Example:
maximum possible number of server cabinets
when calculating with ASD PipeFlow
(with 2 sampling holes per cabinets):

	Shape of the sampling pipe:	
	I-shaped (as show)	U/T/H-shaped
Class A	3	3
Class B	4	4

Fig. 15 Types of equipment monitoring layouts (examples)

4.4.3 Sampling fixtures and sampling holes in equipment monitoring

The number of sampling holes in a sampling fixture and their shape are based on the size of the object's ventilation slot. The following approximate values apply:

Size of the ventilation slot (length x width in cm)	Shape of the sampling fixture	Number of sampling holes	Hole diameter (mm)
< 20 x < 15	I-shaped	2	According to "ASD PipeFlow" calculation
< 30 x < 15	I-shaped	3	
< 40 x < 15	I- or T-shaped	4	
< 80 x < 20	T-shaped	4	
< 40 x < 40	U-shaped	4	
> 40 x > 40	H-shaped	4	



Notice

The sampling fixtures and their sampling holes must be placed directly in front of the object's airflow .
The sampling holes must be facing the outflowing air.

On objects with a high airflow rate (strong ventilation), the sampling holes should be fitted with funnels for optimal smoke detection.

4.5 Tips and notices on planning

Temperature and air pressure

All sampling holes of the tube network and the detector housing must be situated in the same space. If this is not possible, the notices in Sec. 5.1.2. "Mounting location of the detector housing" must be observed.

In spaces with high ambient temperatures of > 50°C and/or a humidity of > 80%, cooling sections may have to be used in the sampling pipe.

Dust and moisture

Applications with a high level of dust and/or high atmospheric humidity require the use of accessory parts as recommended by the manufacturer, e.g.: Dust filter unit, dust trap box, water retaining box or manual ball valve for sporadic cleaning of the sampling pipe using compressed air (see also Sec. 5.4).

In spaces with high ambient temperatures of > 50°C and/or a humidity of > 80%, cooling sections may have to be used in the sampling pipe.

Accessibility

Ideally, all the sampling holes are accessible for cleaning. Cleaning can also be undertaken from the detector housing using compressed air, or under 0°C with nitrogen.

Noises

If the device noises cause disturbance, it can be installed in the ASD sound insulation map case and/or in a side room. See also Sec. 5.1.2.

4.6 Use according to ULC

For use according to **UL** the following alarm sensitivity ranges of the used smoke sensor in the ASD 531 must be adhered to.

① All sampling holes in the tube network shall have a calculated sensitivity value and transport time according to the specifications in the following tables. The "ASD PipeFlow" must be used for the calculation.

4.6.1 Use according to ULC-S529 3rd Ed

Special applications according to ULC-S529 3 rd Ed		
Sampling hole sensitivity range ①	0,02 – 10 %/m	0,0061 – 3,16 %/ft
Air velocity range	0 – 20 m/s	0 – 4000 ft/min
Maximum transport time ①	69 s	
Sampling holes / sampling tube configuration	as defined by the "ASD PipeFlow" calculation software ①	

Open area protection compliant with ULC-S529 3 rd Ed		
Sampling hole sensitivity range ①	1,63 – 5,71 %/m	0,5 – 1,78 %/ft
Air velocity range	0 – 20 m/s	0 – 4000 ft/min
Maximum transport time ①	69 s	
Sampling holes / sampling tube configuration	as defined by the "ASD PipeFlow" calculation software ①	

5 Installation of device and sampling pipe

5.1 Device

5.1.1 Tools for handling the detector housing

The tools listed below are required for mounting and installation

- Opening the detector housing flat-blade screwdriver No. 5 (8 mm)
- Removing the pipe plug flat-blade screwdriver No. 2 (4 mm)
- Securing the detector housing Torx screwdriver T20
- Module holder for additional modules Torx screwdriver T15
- Terminals no. 1 flat-blade screwdriver (3.5 mm)

5.1.2 Installation location of the detector housing



Notice

The following principle must be followed:

All sampling holes and the air outlet must be in the same climate zone.

Climate zone = area with the same air pressure and temperature.

Ideal solution - detector housing and tube network in the same room

The detector housing should ideally be kept in the room to be monitored.

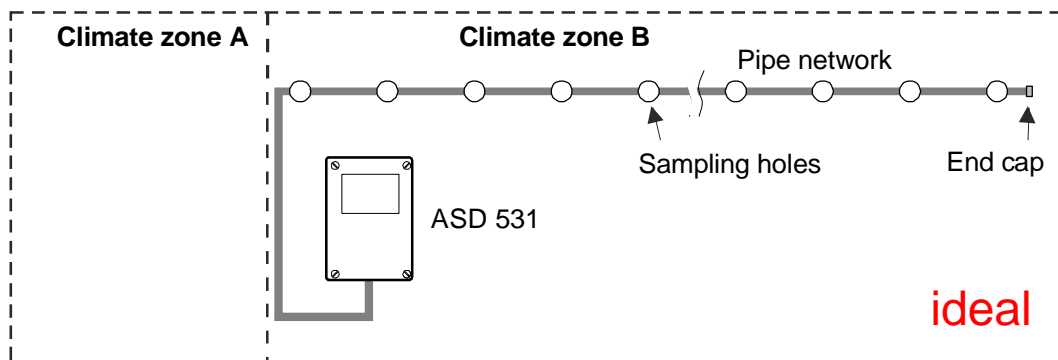

Fig. 16 Detector housing and tube network in the same room

Special solution - detector housing and tube network not in the same room

If the detector housing cannot be kept in the room to be monitored, it must be guaranteed that it is kept in a room which has the same climate zone. A continuous exchange of air between the rooms (e.g. doors or opening in the wall) must be guaranteed.

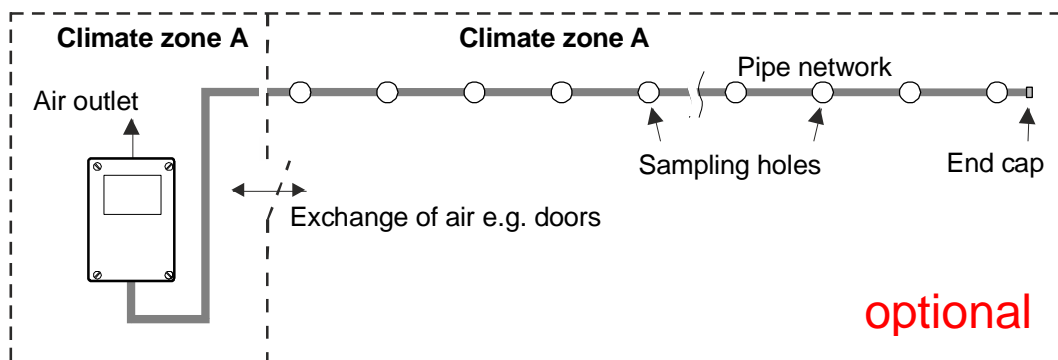

Fig. 17 Detector housing and tube network not in the same room

Installation of device and sampling pipe

Special solution - detector housing and tube network not in the same climate zone

In applications where the sampling pipe and detector housing are mounted in different climate zones, a return of the intake air to the monitored area is required. The return line can be adapted after removing the air outlet pipe plug on the ASD 531 map case.

It is imperative that the “ASD PipeFlow” calculation software is used to calculate the sampling pipe

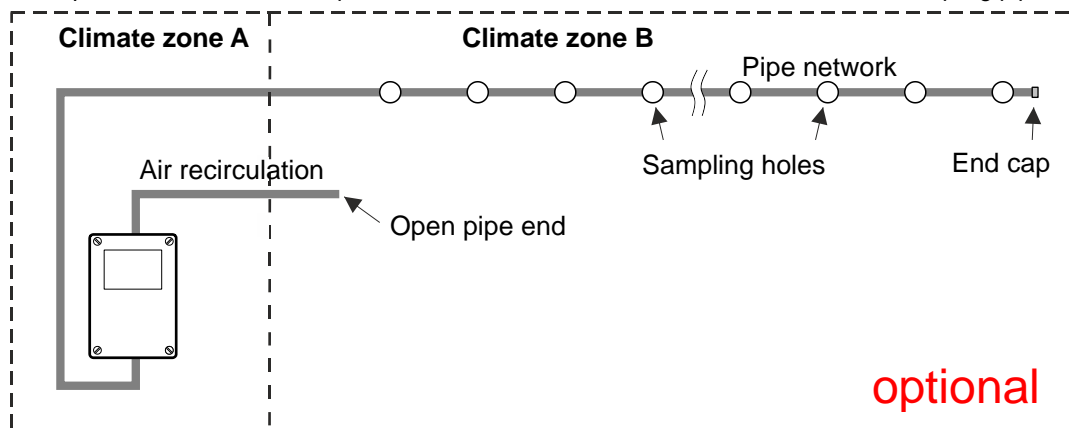

Fig. 18 Detector housing and tube network in different climate zones with air recirculation

Not permitted: Air openings in different climate zones

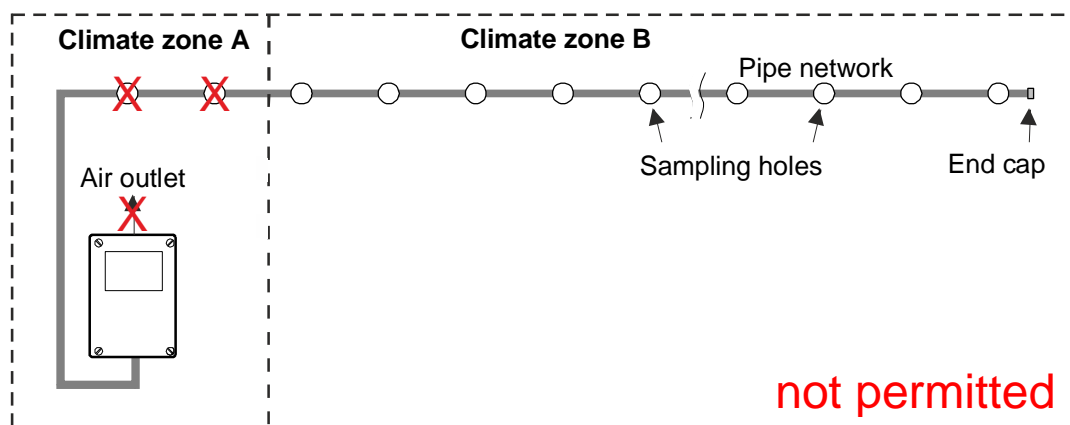

Fig. 19 All sampling holes and the air outlet must be in the same climate zone

To be noted in the case of significant fluctuations in temperature and temperatures under 4°C

Special settings (larger airflow window, longer delay time, etc.) may have to be made in areas with significant temperature fluctuations of more than 20°C at both the sampling pipe and on the detector housing. This also applies to temperature differences of more than 20°C between sampling pipe and detector housing.

If sampling pipes with air at room temperature have to be routed through areas in which the temperature may drop below 4°C, the tube parts in these areas may have to be specially installed (possibly by isolating the sampling pipe as specified by the manufacturer).

5.1.3 Dimensions, drilling plan, entries, etc.

Mounting positions for the detector housing

The detector housing does not require a set position and can therefore be mounted in any position.

To prevent the ingress of dirt, the detector housing ships with the pipe plugs fitted. Likewise all the cable screw unions are sealed.

Default installation

Vertical mounting is ideal due to the labelling of the display element (control unit at the top). The sampling pipe is then inserted into the detector housing from below. This makes it easier to feed the tubes to accessory parts such as dust filter unit and water retaining box, which for physical reasons should always be below the ASD detector housing.

Hanging mounting (180°)

If feeding the sampling pipe into the detector housing from above is unavoidable, the detector housing can also be rotated through 180° and then mounted (i.e. with the control unit at the bottom). To ensure that control unit labelling is not upside down, turn the control unit labelling strips accordingly (see also Sec. 5.1.5).

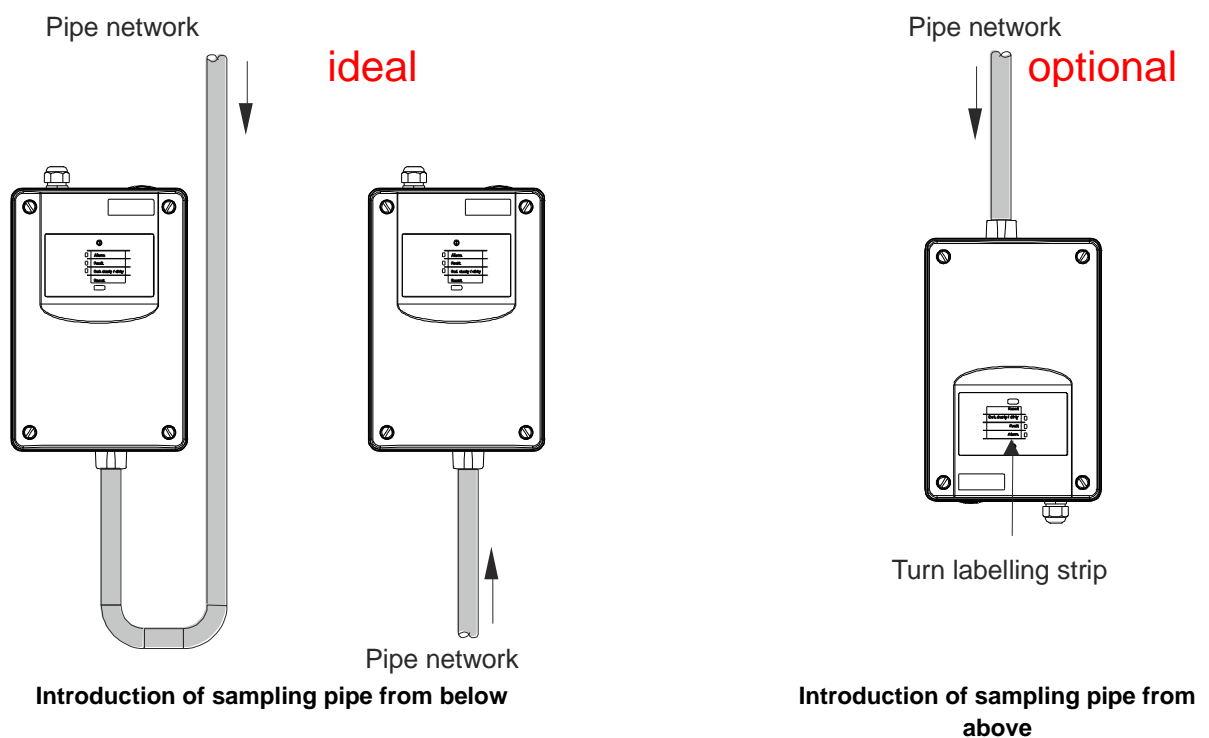

Fig. 20 Mounting position and pipe entries on the detector housing

Pipe entries

The pipe plugs must not be glued in the ASD housing (plug-in connector).

The appropriate pipe plugs must be removed before the pipes are connected.

The entry openings in the detector housing are designed so that the sampling pipe/ recirculation pipe simply has to be plugged into place (conical opening). The pipe should only be glued into place in exceptional circumstances and only after consulting with the manufacturer.

If there is air recirculation to the monitored area, the air recirculation pipes can be connected directly to the detector housing in place of the air outlet pipe plug.

Installation of device and sampling pipe

5.1.4 Installation of the detector housing

An easily accessible installation location should be chosen so that the detector housing can be worked on without aids such as ladders and scaffolding. The ideal installation height of the detector box is about 1.6 m above the ground (top edge of the detector box).

On the entry side of the connection cable, a minimum distance of 10 cm to customer-side parts must be observed.

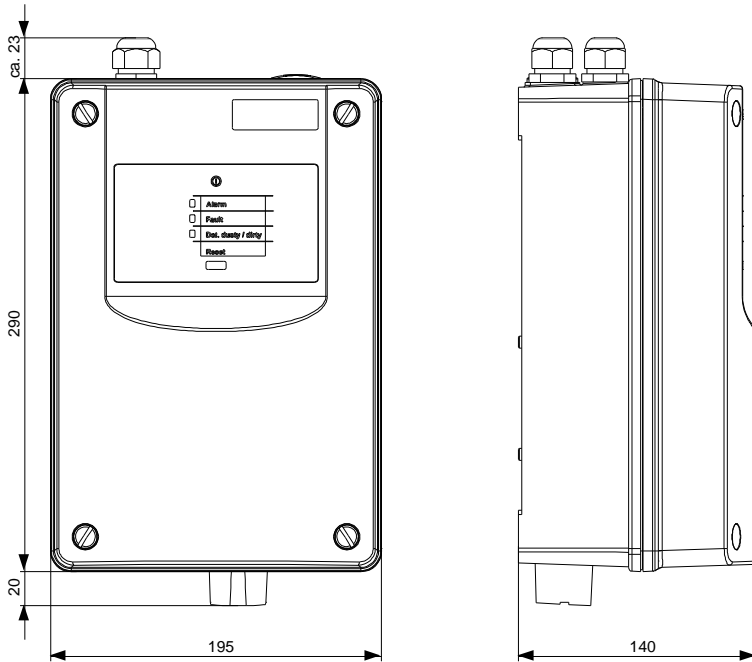

Fig. 21 Detector housing dimensioned drawing

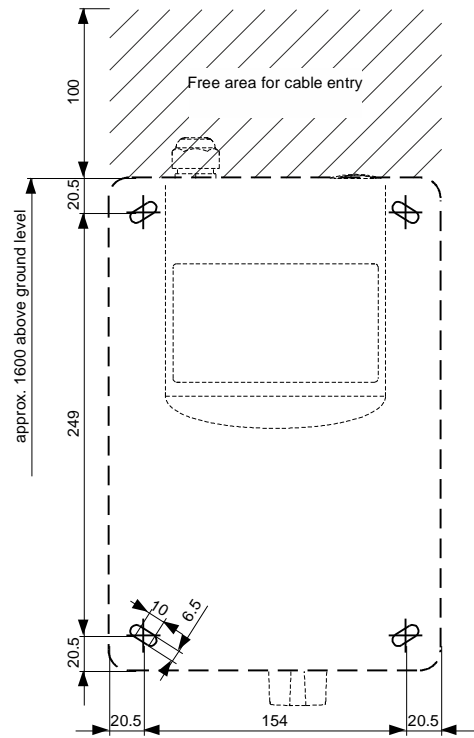

Fig. 22 Detector housing drilling plan

Fastening the detector housing

Once the detector housing is open, the four mounting holes in the housing base are accessible.

The detector housing is fastened with the four supplied Torx wood screws (\varnothing 4.5 x 35 mm) and the four U-washers (\varnothing 4.3/12 x 1 mm) "A". Use a Torx screwdriver T20 to insert and tighten the screws.

The positions of the fastening holes are shown in Fig. 22. When fastening to masonry, use the S6 dowels supplied.

The device can be shifted by a maximum of ± 2 mm horizontally and vertically to correct its mounting position. A rotation correction of approx. ± 5 mm is possible.

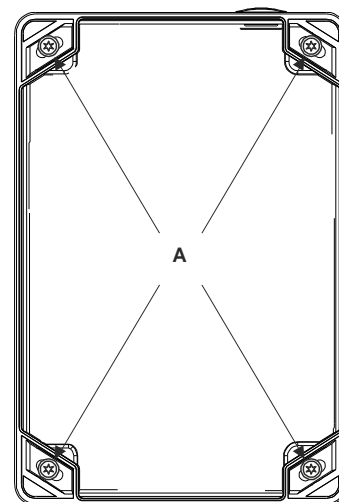

Fig. 23 Fastening the detector housing

5.1.5 Turning the labelling strip

Open the detector housing to turn the labelling strips.

Use the tab to pull the labelling strip out of the cover, turn it over and then use it again.

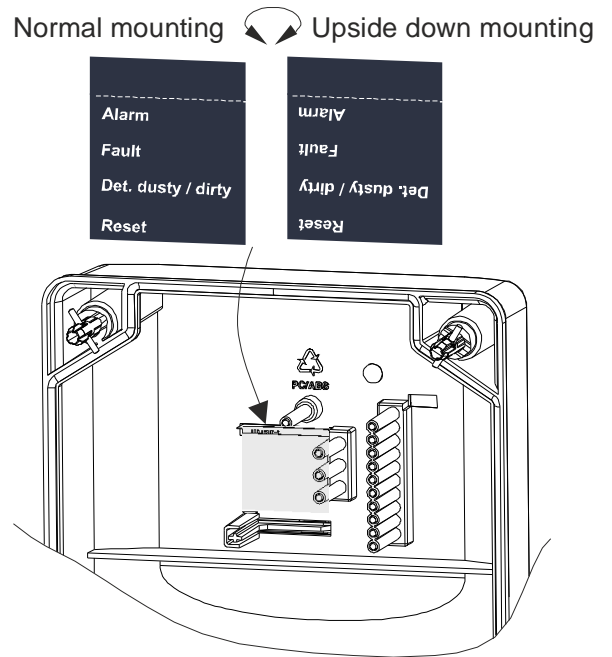

Fig. 24 Turning the labelling strips

5.1.6 Opening and closing the detector housing

To open the detector box, use a **flat-blade screwdriver no. 5** (8 mm). Smaller flat-blade screwdrivers may damage the material of the rotary snap locks.

To actuate the **rotary snap locks**, **press** them **firmly** with the screwdriver towards the housing base and then **turn** through 90°.

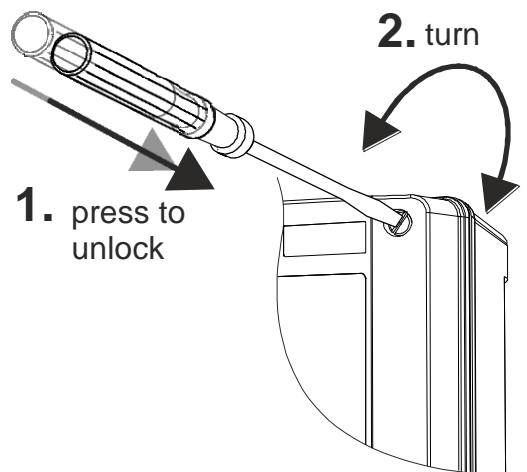

Fig. 25 Turning the snap locks

The position of the lock slit shows the current status:

The rotary snap locks must snap into place in each case.

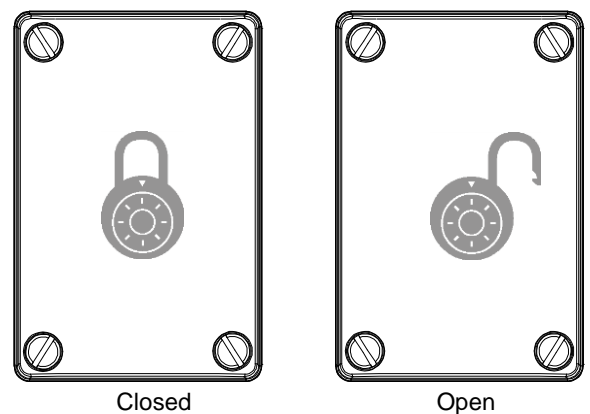

Fig. 26 Position of the snap locks

5.2 Electrical installation

5.2.1 Cable screw unions

There are three M20 cable screw unions in the detector housing for feeding in the electrical installation. If needed, an additional cable screw union (1 x M25) can be fitted in one reserve hole (blind plug).

The cable screw unions are suitable for cables with external diameters ranging between 5 and 12 mm (M20) or 9 and 18 mm (M25).

The device ships with the cable screw unions sealed with a dust-protection insert; remove the inserts before feeding in the cables. Any cable screw unions that are not in use must be replaced with blind plugs (mounting set) to maintain the IP 54 protection class.

5.2.2 Installation cable requirements

The electrical installation is usually performed with commercially available cables. Depending on the country of use, special fire detector cable may be required by the relevant authorities. The relevant country-specific authorities should therefore be consulted concerning the required cable types.

Cables with twisted pairs are to be used as a matter of principle. With 4-wire and multi-wire cables, twin- or quad-twist cables are to be used.

The installation cable must have a minimum wire diameter of 0.8 mm (0.5 mm²). **Please refer to Section 5.2.3 for determining the exact maximum cable length and the required cable cross-section.**

5.2.3 Determination of the conductor cross-section for the power supply

These instructions apply exclusively to the ASD 531 power supply. The cross-sections of the remaining lines must be determined separately.

Calculation:	$A = \frac{I \times L \times 2}{\gamma \times \Delta U}$	I = Power consumption (in A)	L = Single line length (in m)
		2 = Factor for return line	γ = Cu conductivity (57)
		A = Conductor cross-section (in mm ²)	ΔU = Voltage drop (in V)

If a "worst case" view is necessary, it must be carried out by the installer in accordance with the formula above.

Simplified calculation conductor cross-section

In most cases, a simplified method can be used.

Assumptions:

- The nominal voltage of the power supply is 24 V.
--> A permitted max. voltage drop of 10 V is expected.
- Only one ASD 531 (incl. RIM 36 and XLM 35 / ML-SFD) is supplied and no consumers are connected to the open collector outputs. → An ASD 531 power consumption of 165 mA (at 14 V) is expected.

$$\text{Minimum conductor cross-section [mm}^2\text{]} = \text{Single line length [m]} / 1727$$

Example: Line length 400 m

Conductor cross-section [mm²] = 400/1727 = 0.23 [mm²] → **0.5 mm²**

5.2.4 Power supply

5.2.4.1 Basics

- The supply of the ASD 531 must satisfy the country-specific requirements and regulations for fire detection and fire alarm systems (e.g. the power supply unit must be certified for installation conforming to EN 54 in accordance with EN 54-4).
- The power can be supplied via a superordinate fire alarm system or separate power supply unit.
- It must be ensured that in the case of a mains outage, the required bridging time is reached.
- The required conductor cross-section must be taken into account. See Sec. 5.2.3.
- The supply is via terminals 1 and 2. If a redundant power supply line (country-specific) is stipulated, it is routed to terminals 3 and 4.

5.2.4.2 Supply in accordance with EN 54-4

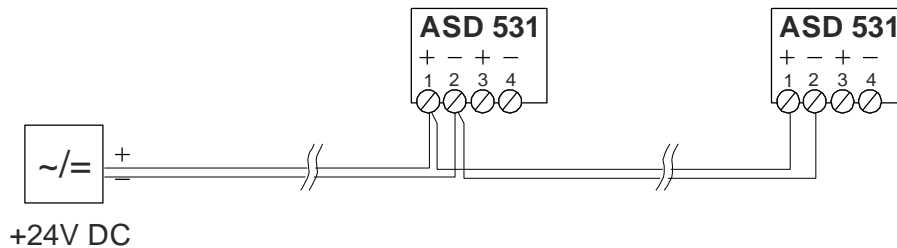

Notices:

- The supply inputs are not connected internally in the ASD and therefore cannot be used for direct forwarding to neighbouring systems.
- The terminals of the ASD 531 are designed for maximum 2.5 mm².

5.2.4.3 Supply with redundant power supply lines (optional, country-specific)

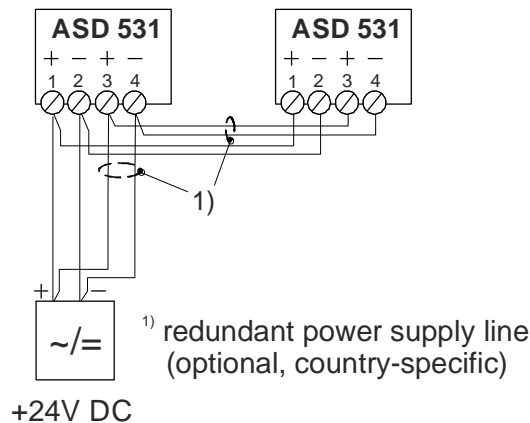

Notices:

- Line redundancy is not monitored by ASD 531.
- The conductor cross-section of both power supply lines must be calculated separately.

5.2.5 Reset input

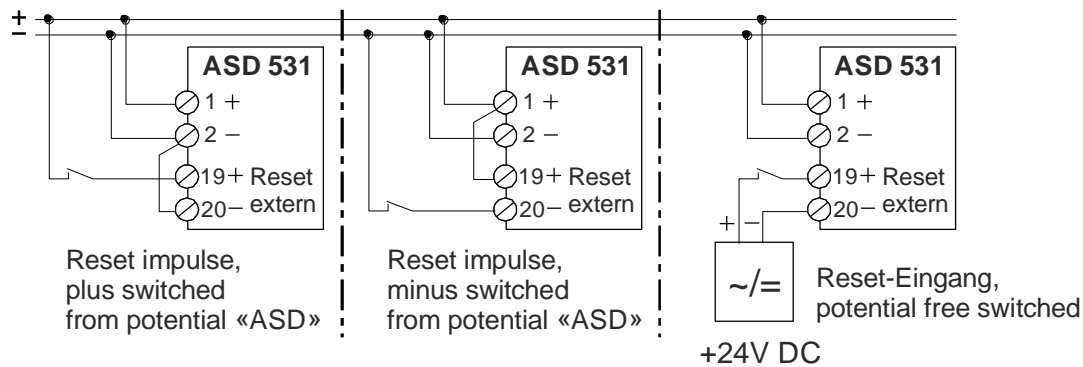

Fig. 27 Connection of the reset input

Electrical properties

The reset input is potential-free (opto-isolator) and can be actuated "plus" side or "minus" side. The input works in the range of 5 to 30 VDC. Thanks to the continuous current consumption of approx. 3 mA across the entire operating range, actuation can be carried out directly via an open collector output.

"Reset" function

Signal duration input: 0.5 to 10 s.

"Switch device inactive" function

Signal duration input: >20 s (continuous signal).

If a continuous signal is imposed for longer than 20 s, the ASD 531 is switched inactive (the ASD 531 triggers a fault) and the fan is switched off. Once the continuous signal is switched off, the ASD is re-armed.

Switching inactive via the "Reset external" input works only if the ASD 531 is not equipped with an XLM 35 / ML-SFD.

5.2.6 Relay contacts

The ASD 531 has several relays with potential-free change-over contacts. The max. contact load is 110 V, 1 A, 30 W.

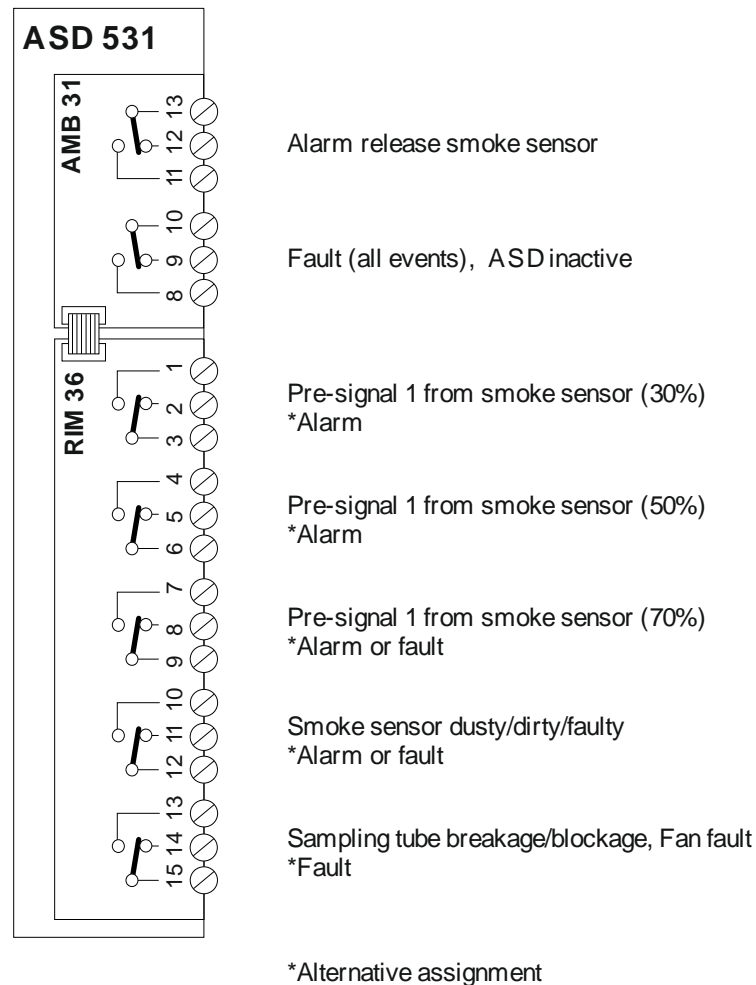

Fig. 28 Connecting the relay contacts

Notices:

AMB 31

- The "Fault" relay is active in normal operation, contacts 08/10 are closed.

RIM 36

- The Relay Interface Module RIM 36 is optional.
- Set the default relay assignment or alternative assignment via the "Relay" DIP switch according to Sec. 6.5.2.2.

Installation of device and sampling pipe

5.2.7 Open collector outputs

The ASD criteria "Alarm" and "Fault" (all fault events) are available as open collector outputs.

Parallel and feedback indicators or other consumers (e.g. relays) can be connected to the open collector outputs.

The outputs are 0-volt switched and have a loading capacity of max. 100 mA per output. The dielectrical strength per output is 30 VDC. The outputs are short-circuit-proof but not potential-free.

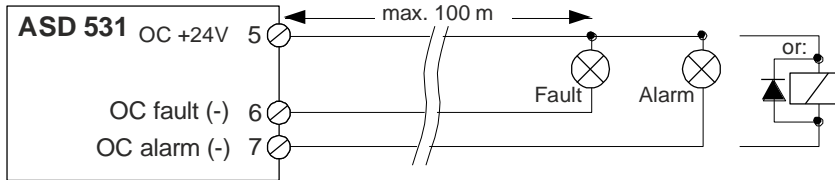

Fig. 29 Connecting the OC outputs

Notices:

- When connecting inductive consumers (e.g. relays), a freewheel diode must be installed directly at the consumer.
- Connection to the outputs affects the overall power consumption of the ASD 531.

5.2.8 Connection to SecuriFire addressable loop with XLM 35 / ML-SFD

The ASD 531 is connected to the SecuriFire addressable loop by means of the optional additional module XLM 35 / ML-SFD.

The state query and the control of the ASD 531 take place directly between the XLM 35 / ML-SFD and the addressable loop.

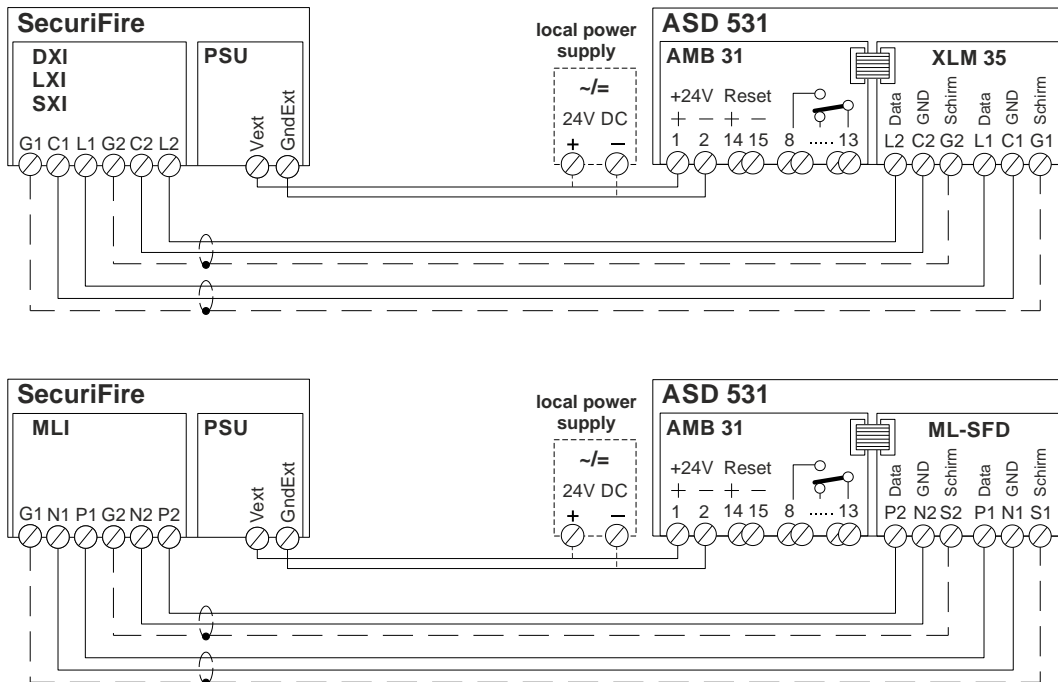

Fig. 30 Connection to SecuriFire addressable loop

Notices:

- The installation of the SecuriFire addressable loop must be screened.
- Power can be supplied to the ASD 531 centrally or locally

5.2.9 Installation of additional modules

XLM 35 / ML-SFD and RIM 36

There are two expansion slots for fitting the detector housing with optional additional modules. The installation location is freely selectable. The XLM 35 / ML-SFD module is connected to the AMB 31 "Option1" module, the RIM 36 to "Option3".

The mounting set of each module comprises a module holder, mounting screw and the connecting cable (ribbon cable) for connecting to the AMB 31. Use a **Torx screwdriver T15** to tighten the mounting screw. The module can be removed from the module holder for mounting in the detector housing and for connection of the electrical installation.

The additional modules are automatically detected when the device is switched on, from which point on they are monitored and functional. When subsequently removing an additional module (e.g. because it is not being used), the user must first log off via operation on the AMB 31 [main board](#) (see Sec. 7.4).

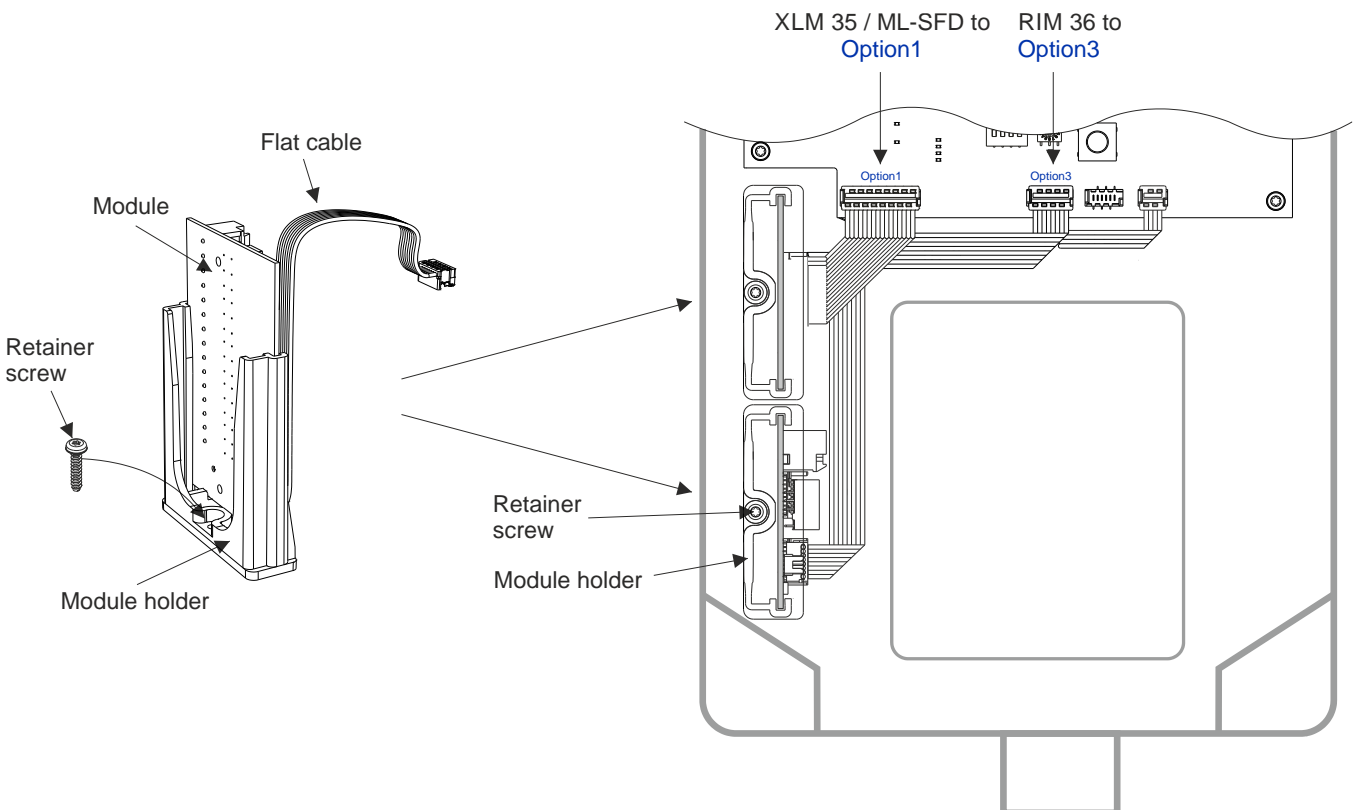

Fig. 31 Installing additional modules

Installation of additional module with UMS 35

The UMS 35 universal module holder is available for installing modules other than XLM or RIM. It is secured in the detector housing instead of the module holders described above and requires both expansion slots. The UMS 35 consists of an angled sheet metal plate with various fastening options for additional modules.

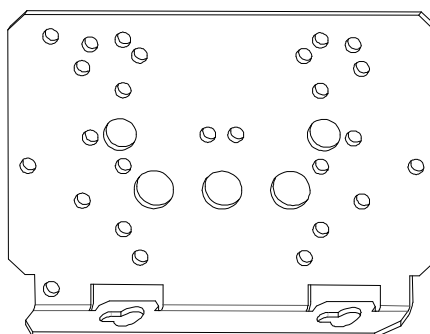

Fig. 32 UMS 35

Installation of device and sampling pipe

5.2.10 Terminal assignments AMB 31, XLM 35 / ML-SFD and RIM 36

Line routing

Inside the detector housing the lines should be fed to the terminals using the shortest possible route. Reserve loops via the [main board](#) are to be avoided (EMC).

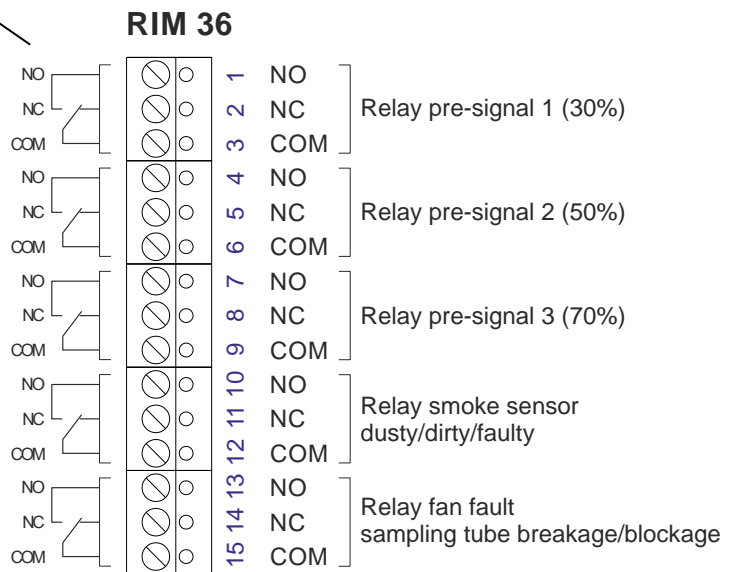
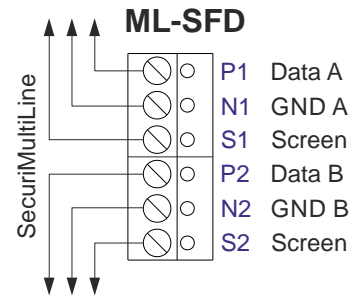
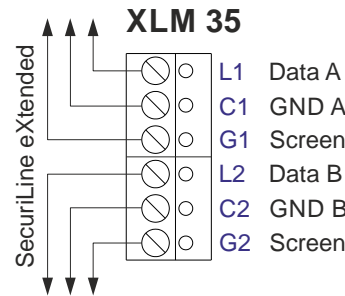
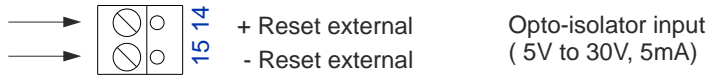
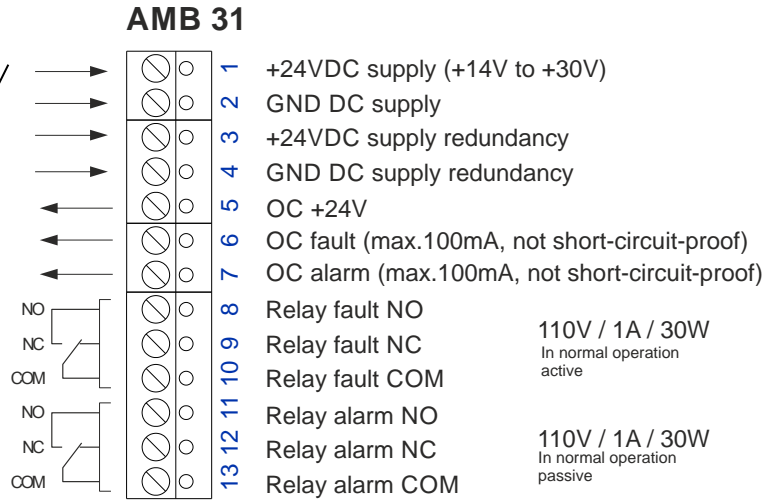
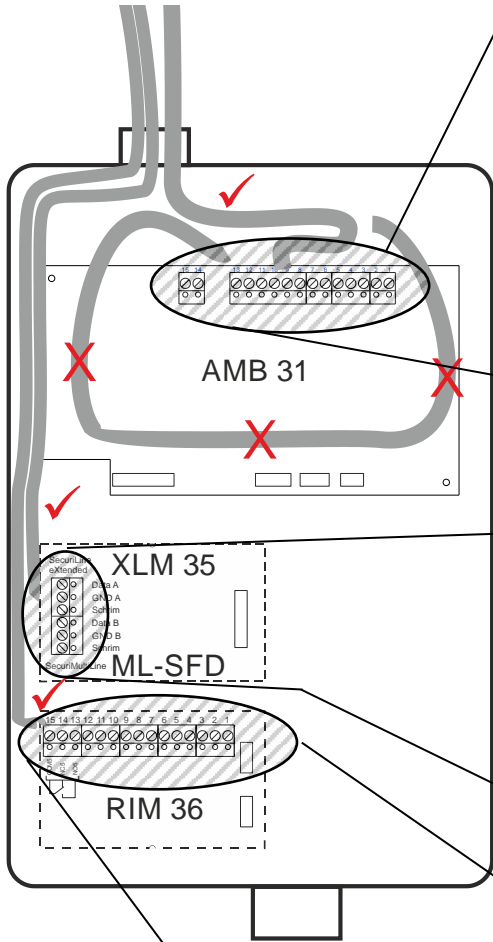

Fig. 33 Terminal assignments AMB 31, XLM 35 / ML-SFD and RIM 36

5.3 Sampling pipe

5.3.1 General

The tube material is available in various plastics and metals. The individual plastic tube parts are usually glued. The flexible tube material for equipment monitoring is pluggable. The metal tubes are connected by means of press fittings.

The rigid plastic tubes can be shaped by heating. The tubes can be painted a different colour, although attention must be paid to the chemical compatibility between paint and tube.

The following materials are available:

Material	Connection
PVC (polyvinyl chloride, contains halogen)	Glue or screw
ABS (acrylonitrile butadiene styrene, contains halogen)	Glue or screw
PA (polyamide, contains no halogen)	Plug-in connection
Copper	Press fitting
Stainless steel	Press fitting



Notice

PVC must not be glued on the ABS.

Transitions from PVC or ABS to PA materials (flexible tube parts) are possible using special adhesive-screw junctions.

5.3.2 Mounting with PVC tubes and fittings

As a rule, if the system operator does not specify a halogen-free installation, the sampling pipe can be made using hard PVC tubing. When PVC tube material is installed, the individual tube parts are glued together using a special PVC adhesive (e.g. Tangit for PVC). The adhesive manufacturer's instructions must be followed. Before gluing, use household paper to remove any dust and grease deposits from the surfaces to be glued (do not use textile cloths). If the tube parts are very dirty, a cleaning agent as specified by the adhesive manufacturer may have to be used.

5.3.3 Mounting with ABS tubes and fittings

If required, halogen-free ABS material can be used for the sampling pipe. When ABS tube material is installed, the individual tube parts are glued together with a special ABS adhesive (e.g. Tangit for ABS). The adhesive manufacturer's instructions must be followed. Before gluing, use household paper to remove any dust and grease deposits from the surfaces to be glued (do not use textile cloths). If the tube parts are very dirty, a cleaning agent as specified by the adhesive manufacturer may have to be used.

5.3.4 Mounting with metal pipes and fittings

Metal tubes (copper, stainless steel) are connected using press fittings according to the manufacturer's instructions. For this purpose, commercially available radial pressing tongs (e.g. radial pressing tongs from the REMS company) with the appropriate V pressing contours can be used.

Installation of device and sampling pipe

5.3.5 Linear expansion

Plastics have sizeable linear temperature expansion coefficient, which is why special attention should be given to the linear expansion (extension and contraction) of the sampling tube. An increase in temperature causes the tube to expand; a decrease in temperature causes it to contract. The importance of taking linear expansion into account increases as the temperature at the time of installation deviates from the usual operating temperature.

Linear expansion can be calculated as follows:

Calculation: $\Delta L = L \times \Delta T \times \alpha$

ΔL = Linear expansion in mm
 L = Length in metres of the sampling pipe between two fixed points
 ΔT = Temperature change in °C
 α = Linear expansion coefficient in mm/m°C
for **PVC** = 0.08
for **ABS** = 0.10

Example: sampling pipe length 20 m, anticipated temperature change 10°C, material PVC:

Calculation: $\Delta L = 20 \times 10 \times 0.08 = 16 \text{ mm}$



Notice

For straight layout the linear expansion can be up to **80 mm** over the total sampling pipe length (40 m) within the permitted temperature fluctuation range (20°C). It is therefore essential to ensure that the sampling pipe is able to "move" (slide) inside the pipe clamps. A distance of 100 mm (0.1 m) must therefore be maintained between the last pipe clamp and the end cap. See also Fig. 34

5.3.6 Mounting the sampling pipe (basics)

Position of the pipe clamps

- Pipe clamps at 1 m intervals are used to fasten the sampling pipe.
- If the sampling pipe or parts thereof are laid out vertically (e.g. in a riser), make sure the tubes cannot slide down (secure clips directly below the fittings as shown in Fig. 35).
- The sampling pipe must be fastened so that the tube is able to "operate" within the clips (linear expansion, see Sec. 5.3.5).
- A distance of at least 0.2 m must be maintained from the T-piece to the clips, starting from the branching points of the sampling pipe, Fig. 34.
- For flush mounting or mounting in false ceilings, ensure that the tubes are not able to start oscillating by themselves.

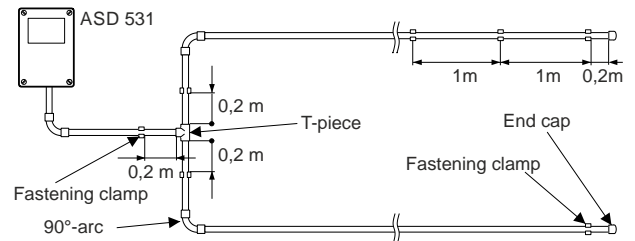

Fig. 34 90° bend, branching point

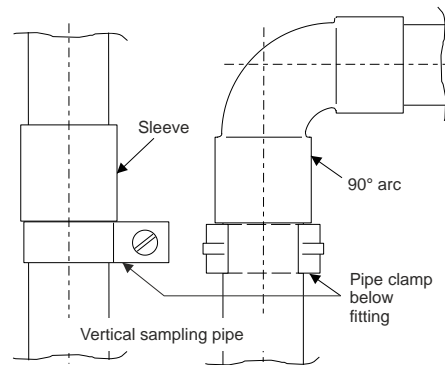

Fig. 35 Vertical sampling pipe

Layout of the pipes

- The tubes must be cut to size using a pipe cutter. In doing so, ensure that the cut is at a right-angle to the tube axis. Remove any projecting burrs, Fig. 36.
- The ends of the individual tube pieces are to be bevelled slightly using a suitable tool, e.g. slightly bevel with a pipe scraper, Fig. 36.

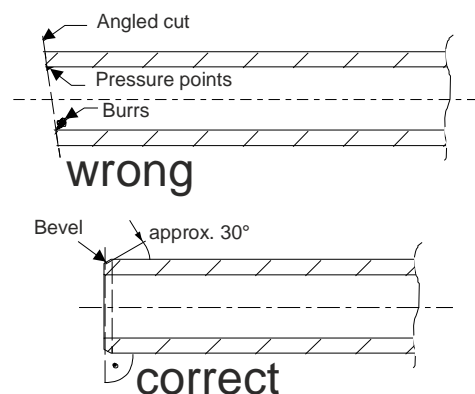

Fig. 36 Cutting the tubes

Connecting the tube parts

- The individual tube sections are connected using fittings. Depending on the tube material used, use either the adhesive process described in Sec. 5.3.2 and 5.3.3 or the pressing process described in Sec. 5.3.4. The tubes are pushed into the fittings as far as the stop, Fig. 37.
- The connection points must be sealed tight to prevent the intake of any leakage air.
- The exact definitive layout of the tubes – particularly in the case of flush mounting – must be documented precisely on the installation plans complete with dimensions.

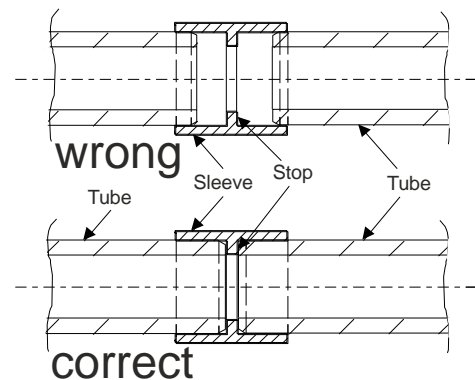

Fig. 37 Assembling the tubes

5.3.7 Creating the sampling holes

The hole diameters for the sampling holes have to be determined and created by the customer as described in Sec. 4.3.6 and according to the specifications of the "ASD PipeFlow" calculation software or according to Sec. 4.4.3.

The sampling holes must be drilled cleanly so that no burrs or pressure points result. Use "new" drills with correctly ground surfaces (Fig. 38).

Whistling noises are a sign that the holes have not been neatly drilled. If so, the holes should be re-drilled and/or deburred.

For space surveillance, the sequence of hole diameters set out in Sec. 4.3.6 and the specifications of the "ASD PipeFlow" calculation software must be observed strictly.

If required, the sampling holes can be made using the special "sampling hole clips" (see Sec. 5.3.8).

For equipment monitoring, the sampling holes are drilled in the sampling fixture. The sampling holes are drilled into the sampling fixture in the direction of the air outlet from the object to be monitored. If required, these sampling holes can be fitted with sampling funnels (Sec. 5.3.10.3).

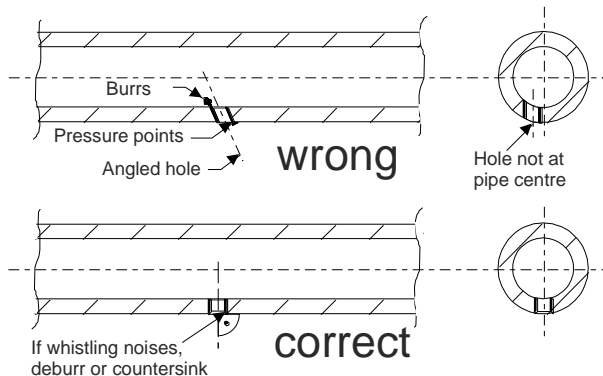

Fig. 38 Creating the sampling holes

5.3.8 Mounting the sampling hole clips and maintenance clips

Possible only with plastic tubes (PVC/ABS)!

At each required position in the sampling pipe drill a hole 8.5 mm in diameter (uniform \varnothing). The holes are made at right angles, in the centre of the pipe axis (as shown in Fig. 38).

The sampling hole clips are available in various sizes (\varnothing 2.0 / 2.5 / 3.0 / 3.5 / 4.0 / 4.5 / 5.0 / 5.5 / 6.0 / 6.5 / 7.0 mm). To determine the required sampling hole clips, refer to Sec. 4.4.3 and the specifications of the "ASD PipeFlow" calculation software or Sec. 4.4.3.

The sampling hole clips and the maintenance clips are clipped onto the sampling tube so they snap into the 8.5 mm borehole, Fig. 39.

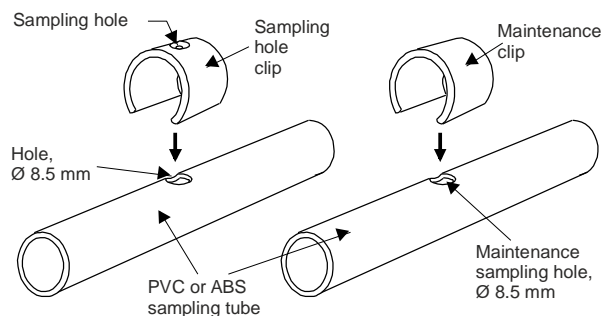

Fig. 39 Mounting clips

5.3.9 Mounting sampling stubs for a ceiling bushing

Possible only with plastic tubes (PVC/ABS)!

The parts required for a sampling stub for a ceiling bushing duct are shown in Fig. 40 A T-piece is built into the sampling pipe at the required point.

The assembly sequence is carried out as indicated by the numbering **1 to 8**.

The sampling hole size (8) is selected based on the specification in Sec. 4.3.6 and/or the specifications of the "ASD PipeFlow" calculation software.

Notice

Make sure the interfaces of the flexible tube are implemented "cleanly" so that the sealing ring in the quick-release coupling is not damaged.

When clicking the flexible tube into place, make sure the tube and the quick-release coupling are pressed firmly against each other to prevent the intake of any leakage air.

The maximum length of the flexible tube must not exceed **1.5 m**.

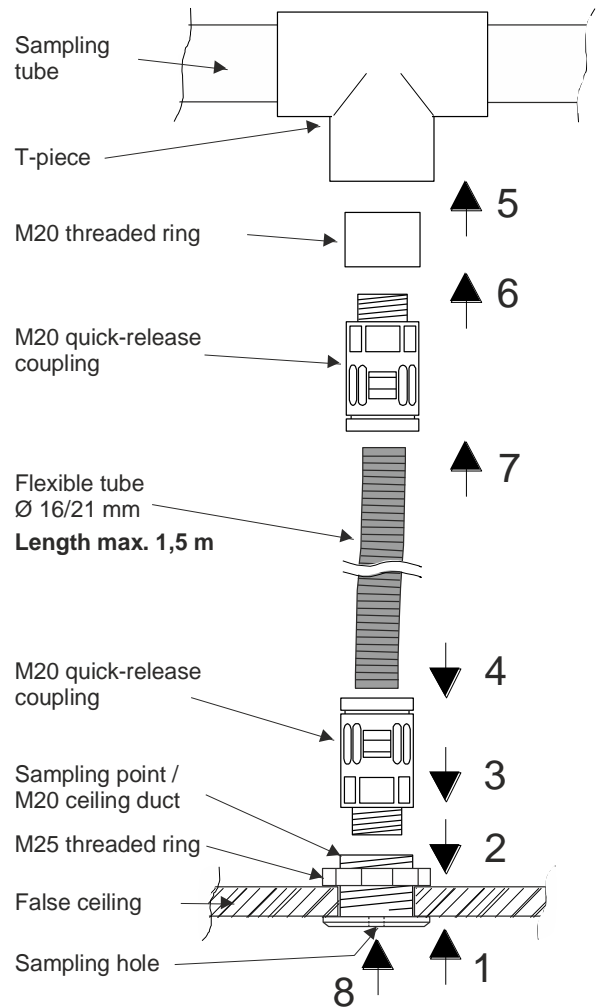

Fig. 40 Mounting the ceiling bushing

Installation of device and sampling pipe

5.3.10 Types of mounting for equipment monitoring

When mounting for equipment monitoring (EDP installations, electrical cabinets, etc.), plastic tube materials are to be used in principle. The same guidelines as described in Chapter 5.3.6 apply.

Equipment monitoring involves monitoring all the air outlet openings of the monitored devices. Please note that an ASD 531 can be fitted with a maximum of six sampling fixtures.

Whenever possible, the sampling pipe and detector housing are always secured directly to the object to be monitored.

5.3.10.1 Screw-free fastening of the sampling pipe

Use the click-on pipe clamps to secure the sampling pipe parts (sampling fixtures) without screws. This allows the sampling fixture or sampling pipe to be removed quickly during maintenance work on the monitored objects.

The click-on pipe clamps are screwed onto the support rails by means of threaded plates.

The support rails are best fastened at right angles to the tube axis to ensure a precise positioning of the sampling pipe (sampling fixture).

Double-sided adhesive tape is used to secure the support rails in the desired position on the object, Fig. 41.

Before using the double-sided adhesive tape, make sure the adhesion surfaces are cleaned with a **non-aggressive** cleaning agent (e.g. soap suds or similar).

Cable ties can also be used for securing purposes instead of the double-sided adhesive tape.

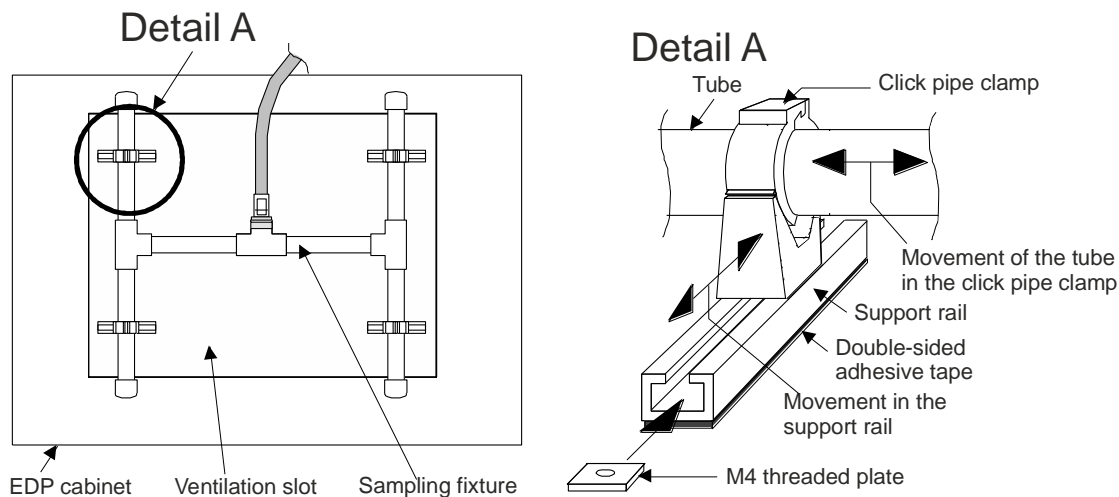

Fig. 41 Screw-free fastening of a sampling fixture

5.3.10.2 Transition to a flexible tube

With equipment monitoring, the transition from rigid to flexible tube can be made in principle using any type of fitting. The parts shown in Fig. 42 are used for that purpose.

For a rigid sampling pipe made of **PVC** a **PVC threaded ring** with M20 internal thread is glued into the exit side of the fitting. The M20 quick-release coupling is screwed into the adapter for the flexible tube.

If the rigid sampling pipe is made of **halogen-free ABS**, the procedure is identical to that for PVC. Here, however, a suitable threaded ring **made of ABS** is inserted instead of the PVC adapter.

The flexible tube is simply snapped into the quick-release coupling and snapped out of it again just as easily for maintenance work.



Notice

Make sure the interfaces of the flexible tube are implemented "cleanly" so that the sealing ring in the quick-release coupling is not damaged.

When clicking the flexible tube into place, make sure the tube and the quick-release coupling are pressed firmly against each other to prevent the intake of any leakage air.

Transition from PVC or ABS fittings to flexible tube

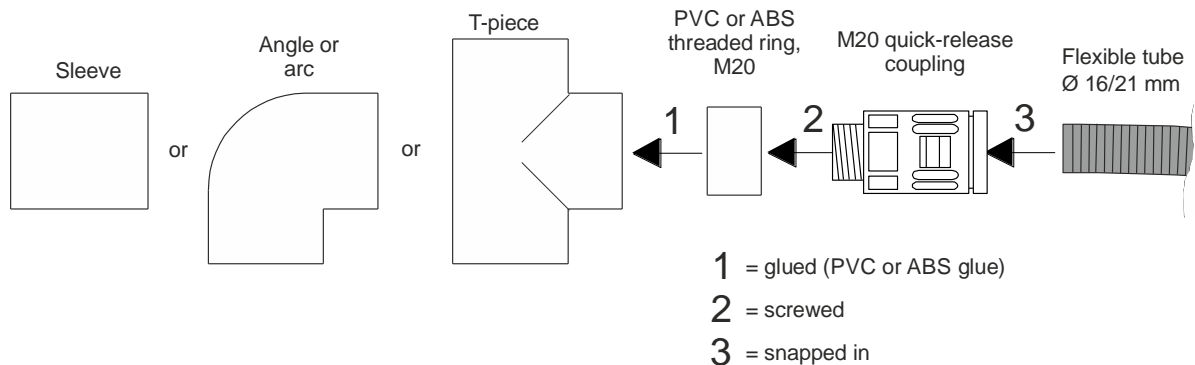

Fig. 42 Transition from fittings to flexible tube

5.3.10.3 Mounting the sampling funnel

Possible only with plastic tubes (PVC/ABS)!

For equipment monitoring objects with a high airflow rate (strong ventilation), the sampling holes can be fitted with funnels for optimal smoke detection.

If forced ventilation is used in rooms and/or on equipment, the use of sampling funnels is imperative.

The sampling funnels are secured to the tube of the sampling fixture and adjusted to the previously drilled sampling holes as described in 4.4.3, Fig. 43.

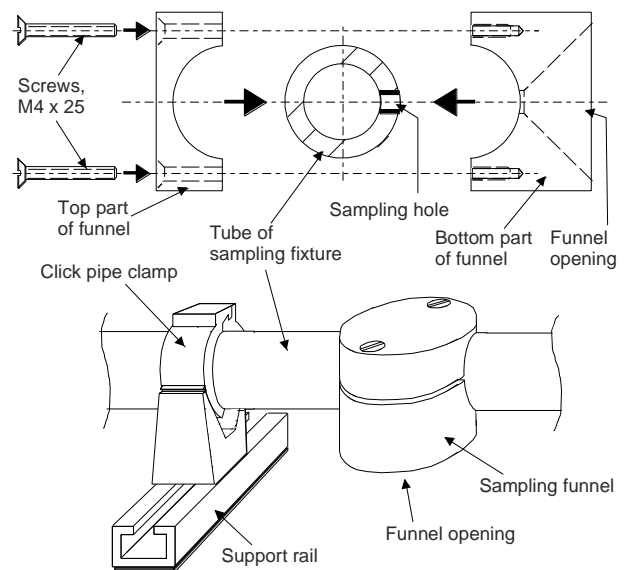

Fig. 43 Using sampling funnels

5.4 Mounting dust filter unit, dust trap box, dust retaining box, water retaining box

Applications with extremely high levels of dust and/or dirt, extreme temperature ranges and/or atmospheric humidity outside the specified limit values require the use of accessory parts as instructed by the manufacturer, e.g.:

- Dust filter unit;
- Dirt trap box;
- Dust retaining box;
- Water retaining box;
- Manual ball valve for sporadic cleaning of the sampling pipe using compressed air;
- Automatic blow out device

Rules when using accessory parts:

The water retaining box, dust retaining box and dust trap box should always be used in conjunction with a dust filter unit.

An automatic blow out device should be used in combination with a dust retaining box or a dust trap box and a or dust filter unit.

Dust filter units, dust trap boxes, dust retaining boxes and water retaining boxes must always be mounted below the detector housing. The water retaining box and dust retaining box must be located at the lowest point (water drain). The specified minimum dimensions (0.5 m) must be adhered to.

The mounting positions for the water retaining box, dirt trap box and dust retaining box must be observed as indicated in Fig. 44.

The dust filter unit and water retaining box must be mounted within the first 2 m of the ASD 531.

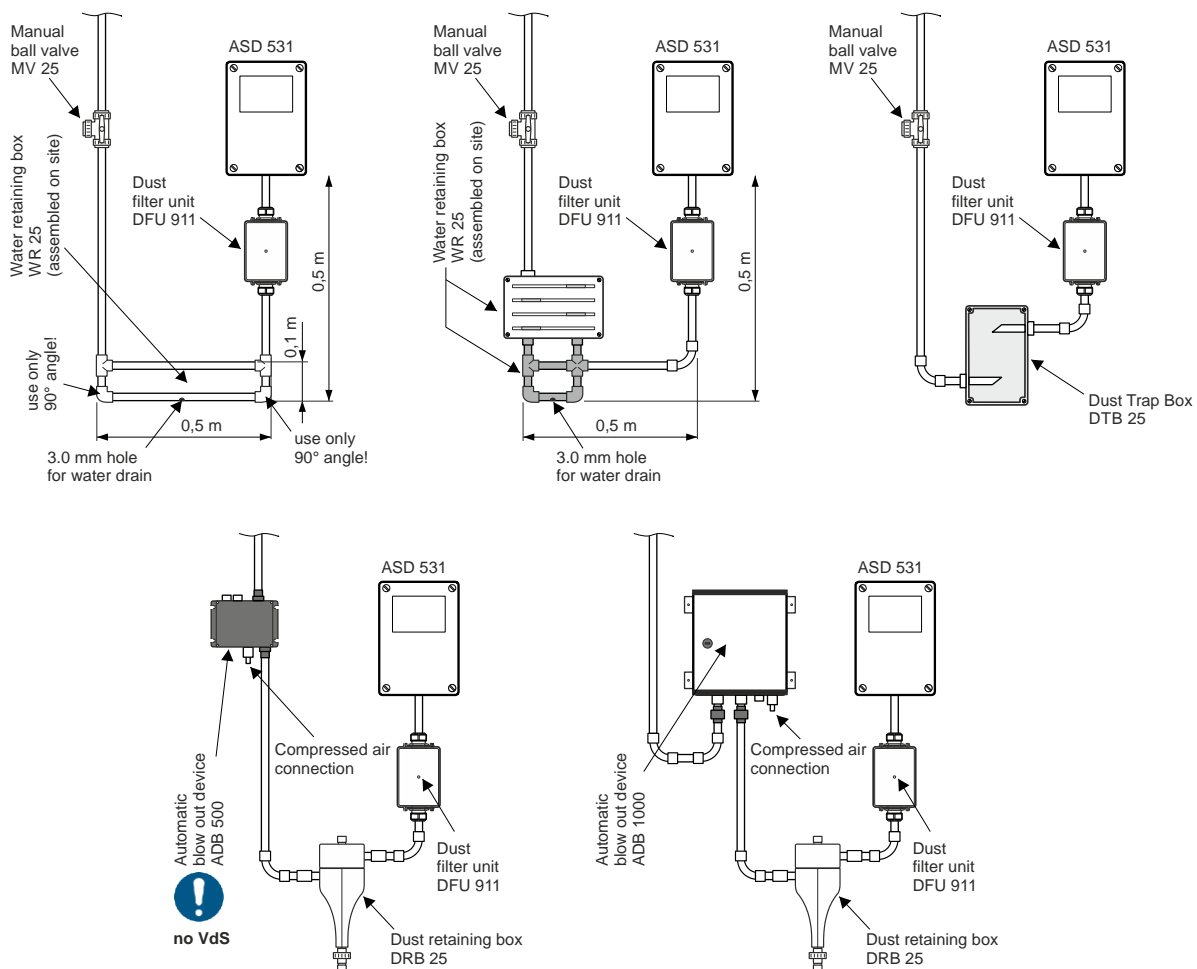

Fig. 44 Mounting accessory parts

6 Commissioning

6.1 Workflow overview

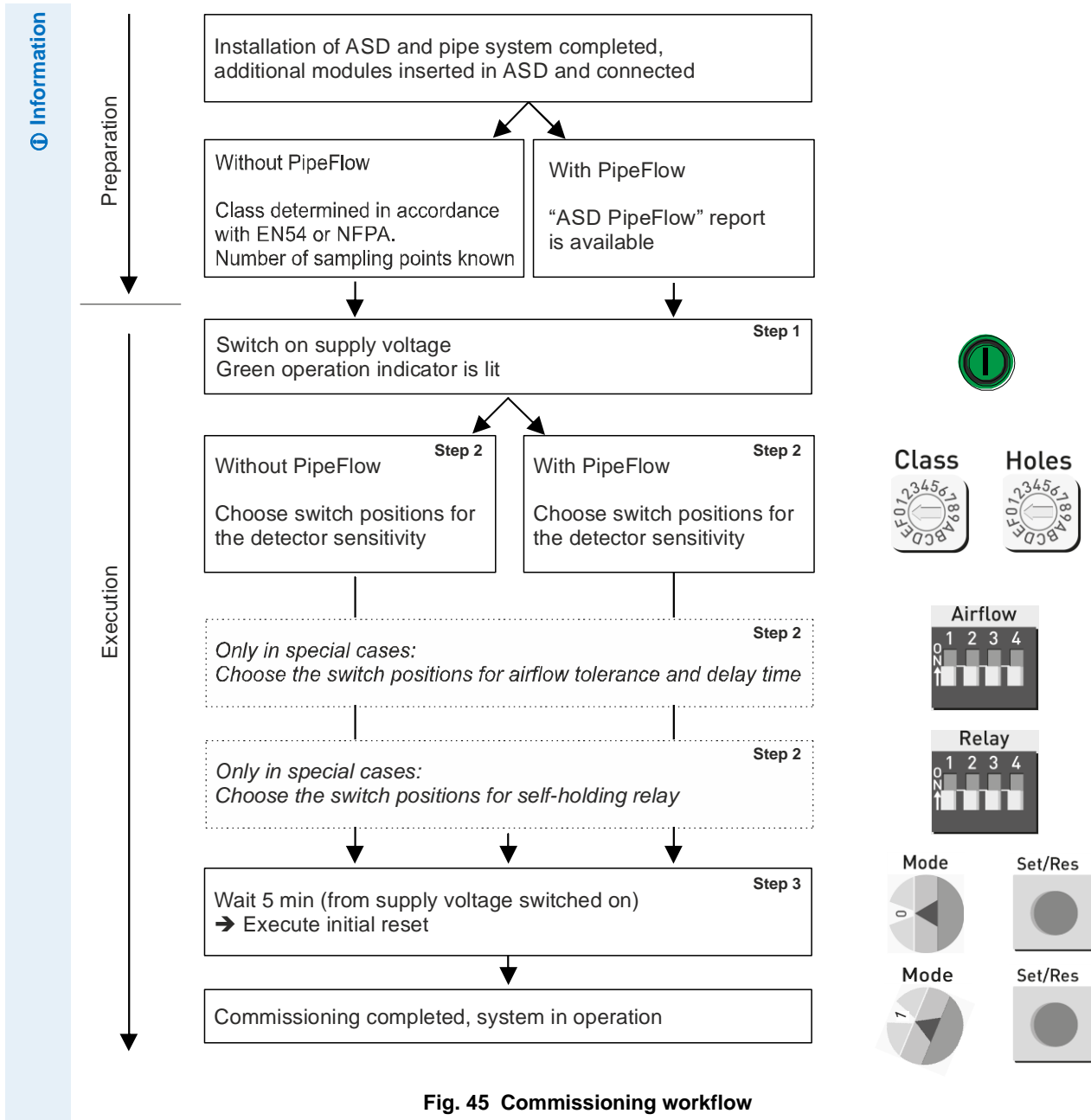

Fig. 45 Commissioning workflow

6.2 Opened detector housing

Information

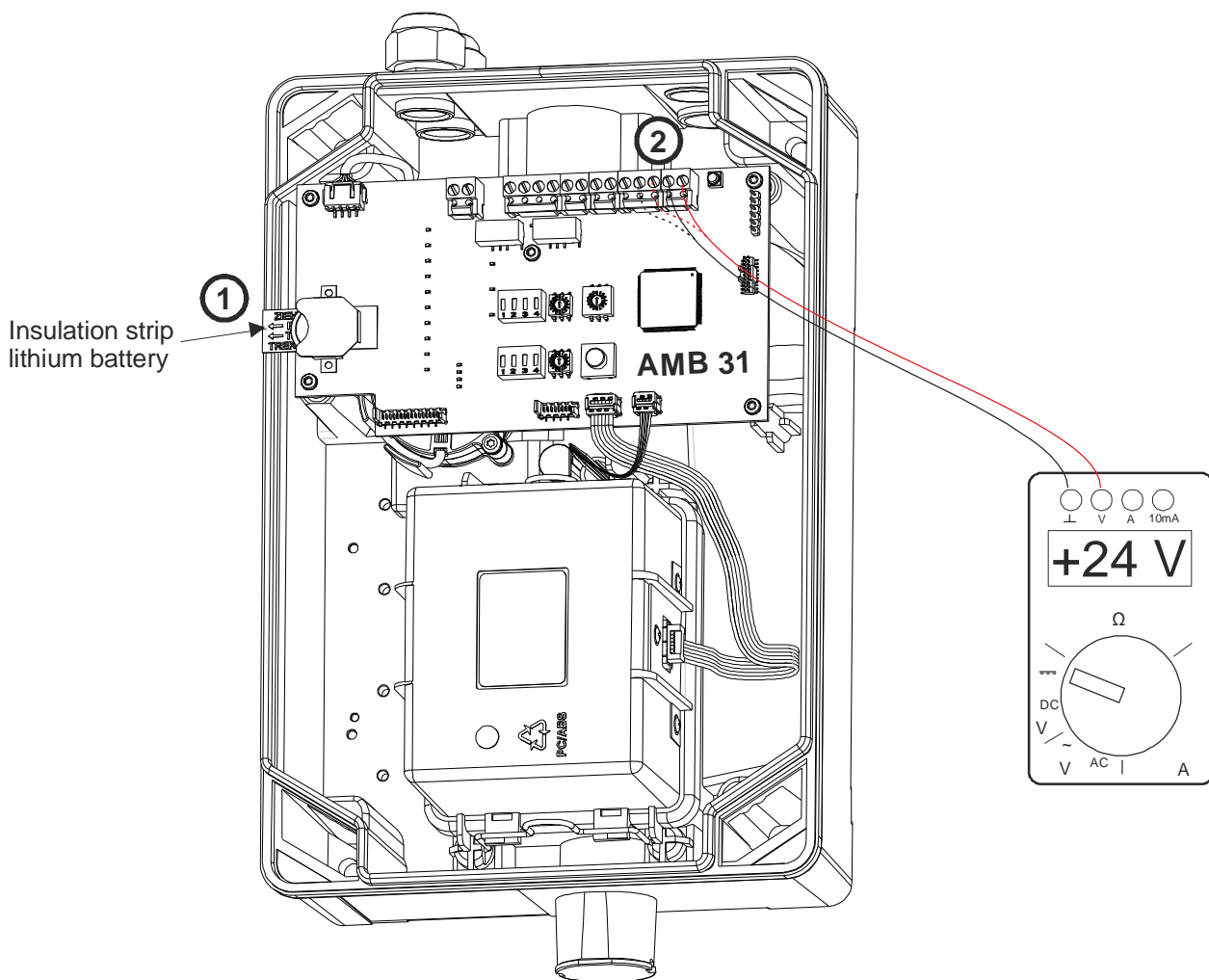

Fig. 46 Detector housing opened for commissioning

6.3 Step 0: Preparations

Check

The following conditions must be fulfilled before commissioning:

Detector housing

- The ASD 531 is finally mounted at the destination.
- The detector housing is opened.
- The electric installation is executed (in accordance with Sec. 5.2). The device is disconnected from power.
- Additional modules are fitted in the detector housing and connected to the AMB 31 main board using the enclosed ribbon cable. See also Sec. 5.2.9
- All fire incident controls and remote alerting processes from the ASD 531 are blocked or switched off.

Sampling pipe

- The entire sampling pipe is laid finally and correctly (connection points, sampling holes, terminations, connection to detector housing, filters).
- If a maintenance sampling hole is provided, it is closed with adhesive tape or the maintenance clip.

6.4 Step 1: Start device

Operation

- Remove isolation strips of lithium battery (on AMB 31) (see Fig. 46 (1)).
- Switch on the ASD supply voltage → The fan starts.
- Check the voltage on terminals 1 and 2 (check also terminals 3 and 4 in the case of a redundant supply): 21.6 to 27.6 VDC (with 24 VDC power supply) (see Fig. 46 (2)).
- Measured voltage value entered in the commissioning protocol (see Sec. 6.8).
- Check the voltage drop on the power supply line and compare with calculation in accordance with Sec. 5.2.3.

6.5 Step 2: Parameterisation of the ASD 531

Information

- "Class" and "Holes" rotary switches → detector sensitivity.
- "Airflow" DIP switch → airflow tolerance and delay time.
- "Relay" DIP switch → state latching state (alarm, pre-signal, fault).
RIM 36 RIM 36 relay assignment.

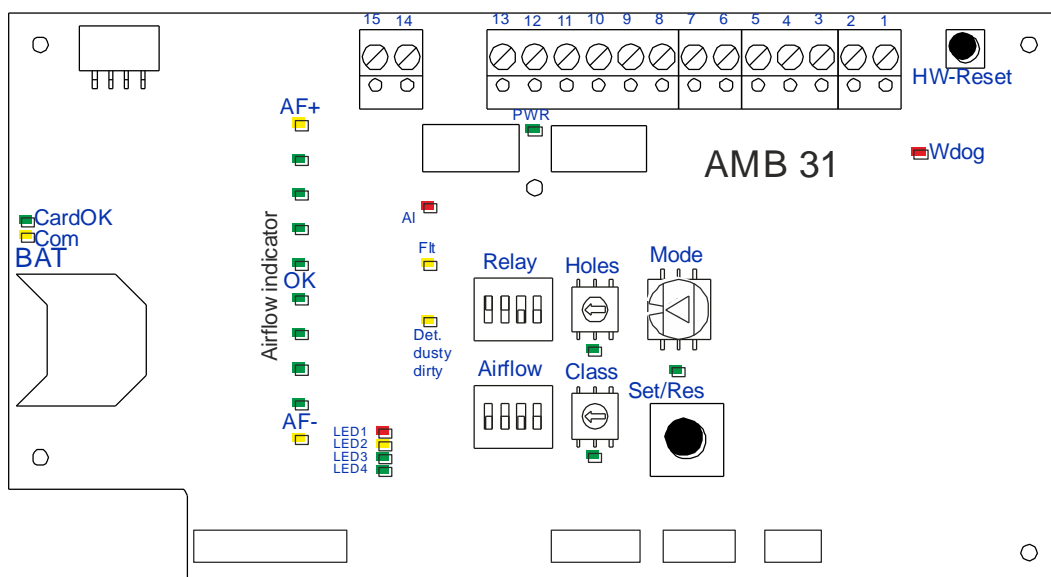

Fig. 47 Control and display elements on the AMB 31

6.5.1 Setting detector sensitivity (BasiConfig)

Information

The required detector sensitivity is set via the "Class" and "Holes" rotary switches on the AMB 31.

Without PipeFlow

Symmetrical tube networks

Prerequisites

The required class in accordance with EN 54-20 and the total number of sampling holes in the tube network are known.

Step 1

"Class" rotary switch:



- Pos. A → EN 54-20 class A, with dust filter / NFPA 75+76 v.e.w. (very early warning)
- Pos. B → EN 54-20 class B, with dust filter / NFPA 75+76 e.w. (early warning)
- Pos. C → EN 54-20 class C, with dust filter / NFPA 72
- Pos. D → EN 54-20 class A, without dust filter
- Pos. E → EN 54-20 class B, without dust filter
- Pos. F → EN 54-20 class C, without dust filter

Other positions are not permitted!

Step 2

"Holes" rotary switch:



Total number of sampling holes in the tube network

- Pos 1 → 1 Opening
- Pos 2 → 2 Openings
- Pos 3 → 3 Openings
- Pos 4 → 4 Openings
- Pos 5 → 5 Openings
- Pos 6 → 6 Openings
- Pos 7 → 7 Openings
- Pos 8 → 8 Openings
- Pos 9 → 9 Openings
- Pos A → 10 Openings
- Pos C → 12 Openings

With PipeFlow

Asymmetrical tube networks, object surveillance

Prerequisites

The required class in accordance with EN 54-20 is known and the current project report from the PipeFlow is available.

Step 1

Identify the calculated parameter for the required class in accordance with EN 54-20 from the report ①.

Step 2

Read the next lowest (more sensitive) value from the "Alarm Sensitivity Table" with reference to step 1 ②.

Read the positions for the "Class" ③ and "Holes" ④ rotary switches from the table.

Step 3

Set the positions of the "Class" ⑤ and "Holes" ⑥ rotary switches in accordance with step 2.

Example for EN 54-20, class A:

	Tube network I
Maximum smoke sensor sensitivity according EN54-20 class C	8.300
Maximum smoke sensor sensitivity according EN54-20 class B	1.400
Maximum smoke sensor sensitivity according EN54-20 class A	0.500

①

Alarm Sensitivity Table	Class			
	1	③ 2	3	
Holes ⑥	1	10.000	1.202	0.144
	2	8.683	1.044	0.125
	3	7.539	0.906	0.109
	4	6.546	0.787	0.095
	5	5.684	0.683	0.082
	6	4.935	0.593	0.071
	7	4.285	0.515	0.062
	④ 8	3.721	② 0.447	0.054
	9	3.231	0.388	0.047
	A	2.805	0.337	0.041
	B	2.436	0.293	0.035
C	2.115	0.254	0.031	
D	1.836	0.221	0.027	
E	1.594	0.192	0.023	
F	1.384	0.166	0.020	

Operation

Information

Notice

If there is a false or invalid entry (e.g. EN class A with nine holes), LEDs "Class" and "Holes", begin to flash after a short delay time. After a second delay time the ASD triggers a fault.

6.5.2 Setting airflow monitoring and state latching

6.5.2.1 Airflow tolerance & delay time

Information

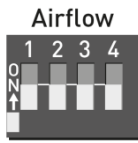

Factory state

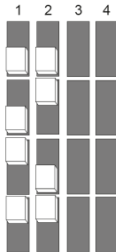

Default setting

This setting ($\pm 20\%/5$ min) corresponds to the factory state and the standard default setting. Other values are not EN tested and may only be used after consulting with the manufacturer.

Airflow tolerance

- $\pm 20\%$
- $\pm 30\%$
- $\pm 50\%$
- $\pm 10\%$

Depending on the use of the ASD 531, it may be necessary to make adjustments to the airflow monitoring. These adjustments relate to the size of the monitoring window (pipe breakage/pipe blockage) and the fault delay time (time until the exceeded monitoring window is reported as a fault). Please note and adhere to the following information:

A variable delay time ensures that disturbance variables, e.g. air turbulence, are ignored.

Delay time

- 5 min
- 10 min
- 20 min
- 10 s
(only for test purposes, not allowed in normal operation)

The **window size $\pm 20\%$** should in principle **not be under-shot**. Smaller window sizes may be set only if, at the same time, the delay time of the airflow monitoring is increased to at least **10 min**. Due to the very high sensitivity of the airflow monitoring when the window size is below $\pm 20\%$ and the delay time is ≤ 5 min, the risk of false alarms due to airflow monitoring faults increases accordingly.

6.5.2.2 State latching and relay assignment on RIM 36

Information



Factory state

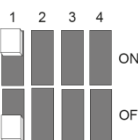

Set switch 1,2,3:

State latching (display, relay and OC)
Also affects relay of a RIM 36

Set switch 4:

Alternative relay assignment on RIM 36

Alarm

- Latching on
- Latching off

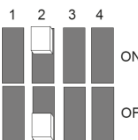

Fault

- Latching on
- Latching off



Pre-signal

- Latching on
- Latching off

Relay assignment on RIM 36

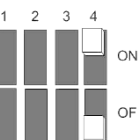

- Alternative relay assignment: Alarm and fault
- Default relay assignment: Pre-signal and fault

6.5.3 Quick guide

A sticker is attached to the inside of the housing cover with brief instructions on commissioning.

Inbetriebnahme

ohne PipeFlow-Berechnung
(nur symmetrische Rohrnetze)

- Anz. Ansaugstellen (Schalter **Holes**)
- Norm./Klasse wählen (Schalter **Class**)
- Ur-Reset (Schalter **Mode** auf Pos. 0 + *mit Taste **Set/Res** bestätigen)
- ASD in Normalbetrieb setzen (Schalter **Mode** auf Pos. 1 + *bestätigen)
- Funktionskontr. (Alarm- & Störungstest)

***Optionale Einstellungen**

- Luftstromtoleranz/Verzögerungszeit
- Relais Selbsthaltung
- Filterfunktion Ein/Aus
- Filterstandzeit verändern

mit PipeFlow-Berechnung
(auch mit asymmetrischen Rohrnetzen)

- PipeFlow-Berechnung des geplanten Rohrnetzes herauslesen
- Empfindlichkeit gem. Berechnung mit Schalter **Holes** und **Class** einstellen (siehe Tabelle)
- Ur-Reset (Schalter **Mode** auf Pos. 0 + *mit Taste **Set/Res** bestätigen)
- ASD in Normalbetrieb setzen + *bestätigen
- Funktionskontr. (Alarm- & Störungstest)

***Optionale Einstellungen**



<http://www.securiton.com/en/manuals/>

Bedienelemente

Set/Res **Tastenfunktion**
– Bestätigung der Position/Funktion des Mode Schalters
– Zurücksetzen von Ereignissen (Alarm/Störung)

Holes **Schalterstellungen**
Pos. 0: Default (Auslieferungszustand, keine Funktion)
Pos. 1–C: Positionen gemäss Anzahl Ansaugstellen (A=10, C=12)

Class **Schalterstellungen**
Pos. 0: Default (Auslieferungszustand, keine Funktion)
Pos. 1: Empfindlichkeitsbereich 1
Pos. 2: Empfindlichkeitsbereich 2
Pos. 3: Empfindlichkeitsbereich 3
Pos. A: EN54-20 A/NFPA 75+76 v.e.w. (max. 6 Löcher), mit Staubfilter
Pos. B: EN54-20 B/NFPA 75+76 e.w. (max. 8 Löcher), mit Staubfilter
Pos. C: EN54-20 C/NFPA 72 (max. 12 Löcher), mit Staubfilter
Pos. D: Wie Pos. A, aber ohne Staubfilter
Pos. E: Wie Pos. B, aber ohne Staubfilter
Pos. F: Wie Pos. C, aber ohne Staubfilter

Mode **Schalterstellungen**
Pos. 0: Ur-Reset (Auslieferungszustand)
Pos. 1: Normalbetrieb
Pos. 2: Isolieren (Alarmausgänge blockiert, für Tests)
Pos. 3: Test-Störung (3× Taste Set/Res)
Pos. 4: Test-Vorsignal (3× Taste Set/Res)
Pos. 5: Test-Alarm (3× Taste Set/Res)
Pos. 6: Abmelden von Zusatzmodulen
Pos. 7: ASD inaktiv (Lüfter/Rauchsensor)
Pos. 8: – Filterfunktion Ein/Aus (Taste Set/Res 10s drücken)
– Filterwechsel (1× Set/Res betätigen)
Pos. 9: – Filterstandzeit auslesen (1× Taste Set/Res)
– Filterstandzeit verändern (1× Taste Set/Res pro 2 Mt.)

Alarmempfindlichkeitstabelle

FW 01.02.xx

Empfindlichkeit wählen Holes & Class	Empf.-bereich 1 (Class Schalter Pos. 1)	Empf.-bereich 2 (Class Schalter Pos. 2)	Empf.-bereich 3 (Class Schalter Pos. 3)
1	10.000	1.202	0.144
2	8.683	1.044	0.125
3	7.539	0.906	0.109
4	6.546	0.787	0.095
5	5.684	0.683	0.082
6	4.935	0.593	0.071
7	4.285	0.515	0.062
8	3.721	0.447	0.054
9	3.231	0.388	0.047
A	2.805	0.337	0.041
B	2.436	0.293	0.035
C	2.115	0.254	0.031
D	1.836	0.221	0.027
E	1.630	0.192	0.023
F	1.384	0.166	0.020

Luftstromwerte
● AF+ (Störung)
Positive Abweichung
● OK 100% (Ur-Reset)
Negative Abweichung
● AF- (Störung)

Luftstrom DIP Schaltereinstellungen

Tolerance	Verzögerung
±20%	5 min.
±30%	10 min.
±50%	20 min.
±10%	10 sec.

Relais DIP Schaltereinstellungen

- Alarm Selbsthaltung
- Störung Selbsthaltung
- Vorsignal Selbsthaltung
- Alt. Relaisbelegung RIM 36

Commissioning

without PipeFlow calculation
(symmetric tube networks only)

- Set number of holes (**Holes** switch)
- Set standard/class (**Class** switch)
- Initial reset (**Mode** switch on Pos. 0 + *confirm with **Set/Res** button)
- Set ASD into normal operation (**Mode** switch on Pos. 1 + *confirm)
- Function control (alarm & fault test)

***Optional**

- Set airflow tolerance and delay
- Set relay latching
- Filter function On/Off
- Change filter service life

with PipeFlow calculation
(asymmetric tube networks also)

- Carry out PipeFlow calculation of planned project
- Set sensitivity acc. calculation with **Holes** and **Class** switch (see table)
- Initial reset (**Mode** switch on Pos. 0 + *confirm with **Set/Res** button)
- Set ASD into normal operation + *confirm
- Function control (alarm & fault test)

***Optional**



<http://www.securiton.com/en/manuals/>

Control elements

Set/Res **Button function**
– Confirmation of position/function on mode switch
– Reset fault/alarm events

Holes **Switch settings**
Pos. 0: Default (delivery status, no function)
Pos. 1–C: Positions according no. of holes (A=10, C=12)

Class **Switch settings**
Pos. 0: Default (delivery status, no function)
Pos. 1: Sensitivity range 1
Pos. 2: Sensitivity range 2
Pos. 3: Sensitivity range 3
Pos. A: EN54-20 A/NFPA 75+76 v.e.w. (max. 6 holes), with dust filter
Pos. B: EN54-20 B/NFPA 75+76 e.w. (max. 8 holes), with dust filter
Pos. C: EN54-20 C/NFPA 72 (max. 12 holes), with dust filter
Pos. D: Like Pos. A, but without dust filter
Pos. E: Like Pos. B, but without dust filter
Pos. F: Like Pos. C, but without dust filter

Mode **Switch settings**
Pos. 0: Initial reset (delivery status)
Pos. 1: Normal operation
Pos. 2: Isolate (alarm outputs blocked, for tests)
Pos. 3: Fault test (3× Set/Res button)
Pos. 4: Pre-signal test (3× Set/Res button)
Pos. 5: Alarm test (3× Set/Res button)
Pos. 6: Log off extension modules
Pos. 7: ASD off (fan/smoke sensor)
Pos. 8: – Filter function On/Off (Set/Res button for 10s)
– Filter replacement (1× Set/Res button)
Pos. 9: – Read out filter service life (1× Set/Res button)
– Change filter service life (1× Set/Res button per 2 mo.)

Alarm Sensitivity Table

FW 01.02.xx

Set sensitivity Holes & Class switch	Sensitivity range 1 (Class switch pos. 1)	Sensitivity range 2 (Class switch pos. 2)	Sensitivity range 3 (Class switch pos. 3)
1	10.000	1.202	0.144
2	8.683	1.044	0.125
3	7.539	0.906	0.109
4	6.546	0.787	0.095
5	5.684	0.683	0.082
6	4.935	0.593	0.071
7	4.285	0.515	0.062
8	3.721	0.447	0.054
9	3.231	0.388	0.047
A	2.805	0.337	0.041
B	2.436	0.293	0.035
C	2.115	0.254	0.031
D	1.836	0.221	0.027
E	1.630	0.192	0.023
F	1.384	0.166	0.020

Airflow Bargraph
● AF+ (fault)
Positive deviation
● OK 100% (initial reset)
Negative deviation
● AF- (fault)

Airflow DIP switch settings

Tolerance	Delay time
±20%	5 min.
±30%	10 min.
±50%	20 min.
±10%	10 sec.

Relay DIP switch sett

- Alarm latching
- Fault latching
- Pre-signals latching
- Alt. relay assignment RIM 36





6.6 Step 3: Initial reset

Check

The following conditions must be fulfilled before the initial reset:

- The environment of the ASD is under "normal conditions"; i.e. ventilation and air conditioning systems, etc. must be in "normal operation". This applies to both space surveillance and the equipment monitoring of ventilated objects.
- If a maintenance sampling hole is provided, it must be closed with adhesive tape or the maintenance clip.
- A waiting period of at least 5 min after the ASD 531 has been switched on must be observed before carrying out an initial reset (see Sec. 6.4 Step 1: Start device).

Operation

-  Set "Mode" rotary switch to pos. "0".
-  Press "Set/Res" key for approx. 1 s. → Initial reset runs (5 to max. 120 s).
-  Set "Mode" rotary switch to pos. "1".
-  Press "Set/Res" key for approx. 1 s.

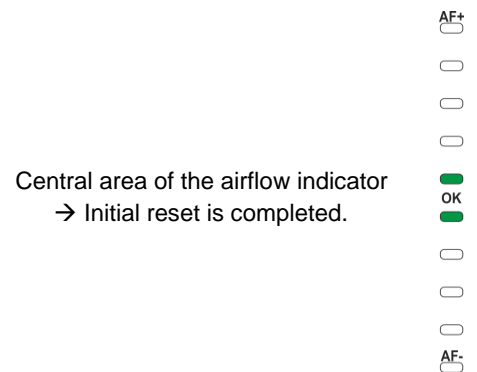

→ The ASD is in the operating state.

The initial reset is used to record the airflow values and to adjust the airflow monitoring to the connected sampling pipe.

Information

A new initial reset must be carried out

- After an extension, upgrade or repair to the sampling pipe
- After a repair to the ASD 531, when replacing the fan, the airflow sensor or the AMB 31 main circuit board
- In the case of an FW upgrade, only if expressly mentioned in the relevant firmware description

6.7 Step 4: Function test





Check

Preparations

- Steps 1 to 3 of the commissioning have been carried out.
- The ASD 531 is in normal operation → no alarm, no fault, airflow at 100%.
- All fire incident controls and remote alerting processes from the ASD 531 are blocked or switched off.

Test of airflow monitoring



Operation

- | | | |
|---|--|--|
| <ul style="list-style-type: none"> • Close the number of sampling holes with adhesive tape until the airflow monitoring is outside the green zone. | <p>→ The yellow "-AF" LED on the AMB 31 is lit.</p> | <p>AF- </p> |
| <ul style="list-style-type: none"> • | <p>→ The yellow "Fault" LED flashes.</p> | <p>Flt </p> |
| | <p>After the LS-Ü delay (5 min) expires, the ASD triggers a fault¹.
→ The yellow "Fault" LED is lit.
→ The FACP signalises the fault.</p> | <p>Flt </p> |
| <ul style="list-style-type: none"> • Reopen the sampling holes closed with adhesive tape. | <p>→ The sampling pipe is in the operating state.</p> | |
| <ul style="list-style-type: none"> • Reset ASD. Via FACP or "Reset" key of ASD. | <p>→ The yellow "Fault" LED goes out.
→ The ASD is in normal operation.</p> | <p>Flt </p> |
| <ul style="list-style-type: none"> • Enter test in commissioning protocol. | | |

Test of alarm release

This test must be individually carried out or repeated for every tube branch.

Operation

- | | | |
|---|--|---|
| <ul style="list-style-type: none"> • Apply test gas to last sampling hole on tube branch ². | <p>→ The red "Alarm" LED is lit.
→ The FACP signalises the alarm.</p> | <p>A1 </p> |
| <ul style="list-style-type: none"> • Check on the FACP | <p>→ Correct group
→ Correct alarm transmission</p> | |
| <ul style="list-style-type: none"> • Reset ASD. Via FACP or "Reset" key of ASD. | | |
| <ul style="list-style-type: none"> • | <p>→ The red "Alarm" LED goes out.
→ The ASD is in normal operation.</p> | <p>A1 </p> |
| <ul style="list-style-type: none"> • Enter test in commissioning protocol. | | |

Information

Notices:

When commissioning and after any changes (repairs) to the sampling pipe, the alarm release must take place from the last sampling hole on the pipe branch. This tests the uniformity throughout the entire sampling pipe.

The alarm release of ASD 531 during regular maintenance and service work can be checked via the maintenance sampling hole. As the sampling pipe is continuously monitored for proper functioning, testing via the sampling pipe is normally not necessary. Once the test is completed, re-seal the maintenance sampling hole (using adhesive tape or maintenance clip).

If a test of the system is required using fire tests, they must be carried out in consultation with the manufacturer.

¹) To shorten the test time, the delay time of the airflow monitoring can be temporarily adjusted to 10 s (airflow switches 3 and 4 to ON). Caution: Set the required delay time once again after the test has been completed.

²) Other suitable test equipment can also be used instead of test gas.

6.8 Commissioning protocol

Information

The ASD 531 ships with the commissioning protocol T140 418 (fold-out) included in the scope of delivery. All of the measurements and tests carried out during commissioning and maintenance are to be entered on the protocol, which is then signed.

When performing maintenance work or after certain other events, conclusions can be drawn concerning the commissioning state of the ASD 531 based on the commissioning protocol. The protocol also serves as a kind of life history of the ASD 531.

Operation

The commissioning protocol is to be filled out conscientiously and fully and stored in the ASD 531. If required, a copy can be made and stored in the system dossier.



Commissioning protocol

ASD 531

Commissioning protocol to ASD 531
Inbetriebnahmeprotokoll zu ASD 531

System No.:

Date Datum	Operating voltage Betriebsspannung (V-DC)		Air flow value Luftstrom (%)	Configuration Konfiguration (Class/Holes)	AI-Test	Fault Test	Remarks Bemerkungen	Visa Visum
	Ø1 / Ø2	Ø3 / Ø4						

7 Further functions

7.1 Reading the airflow

Description

The current airflow can be read at the LED bar on the AMB 31.

If the two middle LEDs are lit, the airflow is 100% (airflow at the time of the initial reset).

A green LED signifies a positive or negative deviation.

Yellow LEDs (AF+/AF-) show an airflow outside the tolerance range.

Display on AMB 31



Airflow

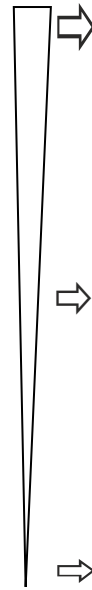

Cause/action

Pipe breakage:
Investigate and repair sampling tube network



Airflow 100% (after initial reset)

Pipe blockage:
Clean sampling holes

Fig. 48 Airflow indicator



7.2 Isolate device

This function suppresses the alarm release (including pre-signals) of the ASD 531. This means that test alarms can then be triggered on the ASD 531 without activating superordinate systems (FACP) (relays, OC outputs, XLM do not trigger). When the "Isolate" function is switched on, a fault is triggered on the ASD and forwarded to the superordinate centre.

-  Set "Mode" rotary switch to pos. "2"
-  Press "Set/Res" button approx 1 sec

Device is isolated
(no alarm transmission)
→ The yellow "Fault" LED is lit, device triggers fault



-  Set "Mode" rotary switch to pos. "1"
-  Press "Set/Res" button approx 1 sec

→ The ASD is in the operating state

7.3 Filter monitoring

If a dust filter unit is installed in the sampling pipe, the "Filter monitoring" function can be activated. This is not "true" monitoring of the soiling level of the filter element but rather only a defined "filter service life" is monitored in the ASD. By default this is 6 months and can be parameterised between 2 and 20 months (in 2-month increments) to accord with the operating conditions. After expiry of this filter service life, the ASD triggers "Filter fault (service life exceeded)". This fault trigger occurs only workdays (MO-FR) at 10 a.m. (see chap. 7.8 Setting the clock (RTC)) and can be reset once. If the filter is not replaced, a fault occurs again in 14 days.

The "Filter replacement" function must be activated on the ASD in order to replace the filter element. The options for this are listed below. When filter replacement is activated, the aspirating smoke detector is set to the "Isolate" state. This insures that falling dust particles from the filter element do not cause a false alarm during the replacement work. After the filter has been replaced, the "Filter replacement" procedure is completed by pressing the "Reset" key on the ASD. This cancels the "Isolate" state and resets the fault on the ASD. "Filter service life" monitoring is restarted.

Filter monitoring On

-  Set "Mode" rotary switch to pos. "8"

-  Press "Set/Res" for approx. 10 s

The green "LED 4" is lit.
→ Filter monitoring is "On"
→ Countdown running

LED4 

-  Set "Mode" rotary switch to pos. "1"

-  Press "Set/Res" for approx. 1 s

→ The ASD is in the operating state

Filter monitoring Off

Same procedure as for "Filter monitoring On".

LED 4 goes out.

Further functions

Read out / change filter service life

-  Set "Mode" rotary switch to pos. "9"

-  Press "Set/Res" for approx. 1 s

The parameterised filter service life is displayed on the LED bar, 2 months per LED
The filter service life is 6 months in the example

Press the "Set/Res" pushbutton to change the filter service life. Two months each time the button is pressed

-  Set "Mode" rotary switch to pos. "1"

-  Press "Set/Res" for approx. 1 s

→ The ASD is in the operating state



Start filter replacement

Prerequisite: filter monitoring is in the "On" state (LED 4 lit)

Note: the "Start filter replacement" function can also be activated by pressing and holding down the "Reset" key for at least 15 seconds when the ASD 531 housing is closed. The "Filter replacement" procedure is terminated by pressing the "Reset" key again. (See also Sec. 8.4).

-  Set "Mode" rotary switch to pos. "8"

-  Press "Set/Res" for approx. 1 s

The red "LED 1" is lit
"Filter replacement started" status
→ ASD smoke sensor is isolated
→ ASD triggers fault
The yellow "Fault" LED is lit
Countdown is restarted

LED1 

Flt



-  Set "Mode" rotary switch to pos. "1"

-  Press "Set/Res" for approx. 1 s

The ASD is ready for the filter replacement

Open dust filter unit and replace the dirty filter element with a clean replacement filter element. Afterwards, close the dust filter unit and filter-box.

Enter the date of the replacement on the new replacement filter element and in the commissioning log.

-  Press "Set/Res" for approx. 1 s

Filter replacement ended
Isolation is cancelled
Fault is reset

→ The ASD is in the operating state

7.4 Logging off additional modules and the SD memory card

Login

A login is not necessary.

The additional modules (XLM 35 / ML-SFD, RIM 36) and [SD memory card](#) are automatically detected when the device is switched on; from that point onwards, they are monitored and fully functional. The [SD memory card](#) begins with data logging, recognisable on the flashing **Com** LED on the AMB.

Logoff

To remove the [SD memory card](#) or remove a fitted additional module (e.g. because it is not being used), the additional modules and [SD memory card](#) must first be logged off.

A time-out (approx. 15 s) is configured for the logoff procedure. During this time the additional modules can be electrically disconnected from the AMB 31 trouble-free or the [SD memory card](#) can be removed from the ASD. If no component is removed during that time, the additional modules are reactivated and data logging continues.

- 
 Set "Mode" rotary switch to pos. "6"

- 
 Press "Set/Res" for approx. 1 s

All the airflow indicator LEDs flash (max. 15 s)
 → Logoff active
 Logoff time is running



- Electrically disconnect (ribbon cable) the relevant additional module from the AMB 31 within the logoff time (15 s) or remove the [SD memory card](#). If the module is not electrically disconnected from the AMB 31 within 15 s, it is reactivated and data logging continues.



- 
 Set "Mode" rotary switch to pos. "1"

- 
 Press "Set/Res" key approx 1 sec

→ The ASD is in the operating state



7.5 Switch device inactive

This function switches off the fan and smoke sensor of the ASD 531. The ASD 531 is then no longer alarm-capable. When the "device inactive" function is switched on, a fault is triggered on the ASD and forwarded to the superordinate centre.

-  Set "Mode" rotary switch to pos. "7"
-  Press "Set/Res" button approx 1 sec

The device is inactive (fan and smoke sensor switched off)
→ the yellow "Fault" LED is lit, device triggers fault



-  Set "Mode" rotary switch to pos. "1"
-  Press "Set/Res" button approx 1 sec

→ The ASD is in the operating state

7.6 Reprogramming

Reprogramming should generally follow the same procedure as for commissioning (see Sec. 0). However, not all the commissioning steps are necessary, depending on the change.

Nevertheless, the applicable system limits must be observed in every case!

In the following it is assumed that the ASD 531 is in fault-free operation, otherwise proceed in accordance with the chapter on commissioning.

7.6.1 Change to the detector sensitivity

The sensitivity of the detector is normatively defined.

The result of changes to the detector sensitivity being necessary (e.g. due to disturbance variables) is that the standards are no longer conformed to. Only carry out in consultation with the manufacturer!

7.6.2 Change to the sampling pipe

The sampling pipe is changed in terms of geometry (number of holes, length, etc.) or in relation to the accessory (installation/removal of filter, etc.).

Preparation:

Clarify whether the new ASD BasiConfig sampling pipe can be used (see Sec. 4.2.1).

Procedure:

1. This step can be skipped for the ASD BasiConfig planning procedure:
 - Open the existing project with PipeFlow
 - Adjust sampling pipe in accordance with the new circumstances
 - Generate new report
 - Determine switch positions for "Class" and "Holes" rotary switches
2. Suppress fire incident control and remote alerting at the FACP
3. Open ASD detector housing
4. Set the "Class" and "Holes" rotary switches to the required positions
5. Execute initial reset. See Sec. 6.6
6. A functional test is recommended. See Sec. 6.7
7. Close detector housing
8. Release fire incident control and remote alerting at the FACP
9. Fill out the commissioning protocol and retain (PipeFlow report too, if necessary)

7.6.3 Changing the airflow monitoring setting

The tolerance and/or the delay time of the airflow monitoring must be increased or decreased.

Procedure:

1. Suppress fire incident control and remote alerting at the FACP
2. Open ASD detector housing
3. Set "Airflow" DIP switch in accordance with Sec. 6.5.2.1
4. A functional test is not strictly necessary. See Sec. 6.7
5. Close detector housing
6. Release fire incident control and remote alerting at the FACP
7. Fill out the commissioning protocol and retain (PipeFlow report too, if necessary)

7.6.4 Changing the setting of the state latching and relay assignment on RIM 36

Procedure:

1. Suppress fire incident control and remote alerting at the FACP
2. Open ASD detector housing
3. Set Relay" DIP switch in accordance with Sec. 6.5.2.2
4. A functional test to check the behaviour of the relay is recommended:
Set the "Mode" rotary switch to the desired position and then briefly press the "Set/Res" key 3x
"Mode" pos. 3: Pre-signal test
"Mode" pos. 4: Alarm test
"Mode" pos. 5: Fault test
5. Set "Mode" rotary switch to pos. 1 (operation) and briefly press the "Set/Res" key
6. Reset the ASD via "Set/Res" key, via ext. "Reset" input or via XLM
7. Close detector housing
8. Release fire incident control and remote alerting at the FACP
9. Fill out the commissioning protocol and retain (PipeFlow report too, if necessary)

7.7 Uploading new firmware to the ASD 531

The firmware download triggers a fault. When upgrading the FW on the ASD 531, it is therefore essential to switch off **fire incident controls and remote alerting** on superordinate systems (FACP) beforehand.

- If present, log off the SD memory card and remove. (See Sec. 7.4 Logging off additional modules and the SD memory card)
- An FW upgrade is performed from the SD memory card. The file of the new FW must first be saved to the SD memory card in the highest directory (not in a subdirectory)
- Insert SD memory card in the ASD



Press "Set/Res" key and hold down



Briefly press "HW reset"



Release "Set/Res" key

- LED1 is lit (Bootloader)
- "Wdog" LED is lit
- "Flt" LED is lit



see also ¹⁾

- FW upgrade is completed
- LED1 – 4 flash (approx. 4 x)
- LED2 is lit
- "Com" LED is lit

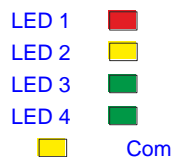

- Start-up phase
- Fault is reset
- ASD start phase runs ("Fault" LED flashes for about 60 s)
- ASD is in the operating state again with the previous settings



¹⁾If the described display does not occur (reason: incompatible, third-party or no FW on the SD memory card), refer to the instructions of the concerned firmware description.

Notices:

Normal data logging then begins automatically on the SD memory card. If this is not wanted, the SD memory card must be logged off and removed after the FW upgrade.

Observe the firmware description for the loaded FW:

If the necessity of a new initial reset is expressly mentioned → An initial reset should be carried out after waiting at least 5 min from normal operation starting.

7.8 Setting the clock (RTC)

The ASD 531 has a real-time clock (RTC) which is buffered by a lithium battery. The time and date are used for the recording of events and of log data. Setting the clock to the current time is not strictly necessary, however it is recommended for systems in complex surroundings with an increased frequency of faults. If this is done, the correct time stamps are entered in the event memory and in the log files.

- Create file "Date.txt"
 - Edit the file with desired time and date with this syntax: hh:mm:ss;DD.MM.YYYY;
(e.g. 12:34:58;29.05.2015;)
 - Save the file on the SD card in the root
 - As soon as the SD card is inserted in the supplied ASD, the clock takes on the setting and the file is deleted
- The clock is set

7.9 Expansion of the event memory

The internal event memory (max. 1000 events) can be supplemented by an SD card.

As soon as an SD card is inserted in the ASD 31, the event file E000.aev is automatically created on it (max 64,000 events). Up to a maximum of ten files (E000.aev – E009.aev) with a total of 640,000 events are created.

7.10 Reading and interpretation of events

7.10.1 ASD is operated without SD card

An SD card is required in order to read a copy of the internal event memory.

- Insert the SD card in AMB
- Make a note of the current time (for reason see Sec. 7.10.3 Interpretation of events)
- Log off SD card and remove. See Sec. 7.4

→ The E.aev file on the SD card contains the content of the internal event memory (max. 1000 events)

7.10.2 ASD was operated with SD card

The events are saved on the SD card.

- Make a note of the current time (for reason see Sec. 7.10.3 Interpretation of events)
- Log off SD card and remove. See Sec. 7.4

→ The Exxx.aev file(s) on the SD-card contain(s) the events (max. 640,000 events)

→ The Exxx.aev file(s) on the SD-card contain(s) the events (max. 640,000 events)

7.10.3 Interpretation of the event data

- Open/import the event file E.aev or E00x.aev with Excel (tab separator)

	A	B	C	D
1	SD card event file S			
2	-----			
3	File version: 001			
4	Device type: 31			
5				
6	FW: V00.00.20			
7				
8				
9	Date	Time	Error group	Event
10	28.05.2015	07:11:10	0	1
11	28.05.2015	08:23:54	30	1
12	28.05.2015	11:32:02	80	16
13	28.05.2015	11:32:20	80	16
14	28.05.2015	11:32:37	80	16

→ One event is listed on each line (date, time, error group, event)

"Date/Time" columns:

The entries are correct if the time (RTC) has been set (see Sec. 7.8). Otherwise "logoff module" is calculated and used to correct the time difference from the noted time and the most recent event.

"Error group/Event" columns:

The significance of the event message is described in Sec. 7.10.3.2.

e.g.:

event code: G80 016

G80, Event 016

G80 = AMB fault

016 = Rotary switch fault

Further functions

7.10.3.1 Event groups

Event group	Purpose
G00	General events, part 1 (ASD On/Off, inactive, start initial reset, smoke sensor on/off from FACP)
G01	General events, part 2 (time, clear event memory)
G03	General events, part 3 (configuration change)
G04	General events, part 4 (reset events)
G10	Smoke sensor events (alarm, dust/dirt, pre-signals, alarm 2)
G11	Smoke sensor faults, part 1 (communication to ASD)
G12	Smoke sensor faults, part 2 (smoke sensor events)
G13	Isolate smoke sensor (On/Off, test results)
G14	Test trigger from BasiConfig
G16	Smoke sensor: Filter faults, filter replacement
G30	Airflow monitoring sampling pipe (pipe blockage, pipe breakage, LS-Ü parameters, air flow sensor def./lacking)
G50	Fan faults (tacho signal, regulator, current consumption)
G60	Initial reset faults (various initial reset parameters, initial reset time-out , airflow too low)
G70	RIM faults
G71	XLM faults
G73	Memory card faults
G80	AMB faults (undervoltage, clock)
G81	Operating system faults

7.10.3.2 Event codes within event groups

G00, general events, part 1	
001	Switch on ASD (supply voltage)
002	Initial reset carried out (ASD)
004	ASD switched off (inactive, via "External reset")
008	ASD switched on (via "External reset")
016	Smoke sensor switched off from FACP (SecuriFire)
064	Smoke sensor switched on from FACP (SecuriFire)
G01, general events, part 2	
001	Date, time set
016	Event memory deleted
G04, general events, part 4, reset results	
001	Key
002	SecuriLine / SecuriMultiLine
008	External
G10, smoke sensor events	
001	Alarm
002	Dust
004	Dirt
008	Pre-signal 1
016	Pre-signal 2
032	Pre-signal 3
G11, smoke sensor faults, part 1	
001	ASD <> smoke sensor communications
002	Unknown smoke sensor type
004	Response sensitivity too low
008	Invalid parameters
G12, smoke sensor faults, part 2	
001	Measuring chamber
002	Temperature
004	Supply voltage
008	EEPROM access error
016	EEPROM invalid data
032	Manufacturing

G13, isolate smoke sensor	
001	Isolated alarm
002	Isolate switched on
004	Isolate switched off (normal operation)
008	Isolated pre-signal 1
016	Isolated pre-signal 2
032	Isolated pre-signal 3
G14, test trigger from <i>BasiConfig</i>	
001	Alarm test
002	Fault test
004	Pre-signal 1 test
008	Pre-signal 2 test
016	Pre-signal 3 test
G16, smoke sensor: Filter faults, filter replacement	
001	Smoke sensor: filter fault (service life exceeded)
016	Smoke sensor: filter replacement started
G30, airflow monitoring sampling pipe	
001	Pipe blockage sampling pipe or filter element is not inserted (if DFU 911S is used)
002	Pipe breakage
004	Invalid LS-Ü parameters
008	Air flow sensor, defective / missing
G50, fan faults	
001	Tacho signal missing
002	Motor regulation outside range
G60, initial reset faults	
004	Initial reset time-out
008	Invalid parameters for initial reset
G70, RIM faults	
001	RIM fault, lacking or defective
064	Incompatible RIM fault
128	RIM fault, too many RIMs
G71, XLM faults	
004	ML-SFD fault, lacking or defective
008	Too many ML-SFDs or non-permitted module combination
016	XLM fault, lacking or defective
064	Too many XLMs
G73, SD memory card faults	
001	SD memory card fault, missing or defective
002	SD memory card communication error
G80, AMB faults	
001	Fault: Air pressure sensor
002	Fault: Temperature sensor
004	Fault: Undervoltage
008	Fault: Clock
016	Fault: Rotary switch
G81, Operating system faults	
001	Fault: Mailbox unknown error
002	Fault: Mailbox pool (memory full)
004	Fault: Other faults
008	Fault: Timer
016	Fault: Mailbox memory cannot be enabled
032	Fault: Buffer overflow option module
064	Fault: EEPROM

Further functions

7.11 Record and interpret log data

It is vital to ensure beforehand that the date and time of the ASD 531 are correct. See Sec. 7.8.

As soon as an SD card is inserted in the AMB 31, the log data file L000.xls is automatically created on it.

Values for smoke and airflow as well as other analogue values (sensitivity, soiling, air pressure, temperature on AMB, voltage at AMB) are saved every second.

After 8 h in each case, an additional log file L001.xls - L199 is generated. The data for anything up to the last 66 days is recorded.

The data can be interpreted in Excel and shown as a graphic if required.

	A	B	C	D	E	F	G	H	I	J
1	SD card log file S									
2	-----									
3	File version: 001									
4	Device typ: 31									
5										
6	FW: V00.00.20									
7	Interval[s]: 001									
8	Smoke peak memory: off									
9										
10	Counter	Time	Smoke lev	Sensitivit	Dirt sens	Air level	Air Press	TempSen	PWR AMB	[\ Day / Night
11	0	28.05.2015 07:11	0	0	0	0	0	0	22.44	Day
12	1	28.05.2015 07:11	0	0	0	0	0	0	22.44	Day
13	2	28.05.2015 07:11	0	0	0	0	0	0	22.43	Day
14	3	28.05.2015 07:11	0	0	0	0	0	0	22.43	Day
15	4	28.05.2015 07:11	0	0	0	0	0	0	22.42	Day
16	5	28.05.2015 07:11	0	0	0	2	0	0	22.42	Day
17	6	28.05.2015 07:11	0	0	0	18	0	0	22.42	Day
18	7	28.05.2015 07:11	0	0	0	35	0	0	22.42	Day
19	8	28.05.2015 07:11	0	0	0	53	0	0	22.42	Day
20	9	28.05.2015 07:11	0	0	0	74	0	0	22.41	Day
21	10	28.05.2015 07:11	0	0	0	97	0	0	22.41	Day
22	11	28.05.2015 07:11	0	0	0	120	0	0	22.41	Day
23	12	28.05.2015 07:11	0	0	0	141	0	0	22.41	Day
24	13	28.05.2015 07:11	0	0	0	159	0	0	22.42	Day

8 Indicators and operation

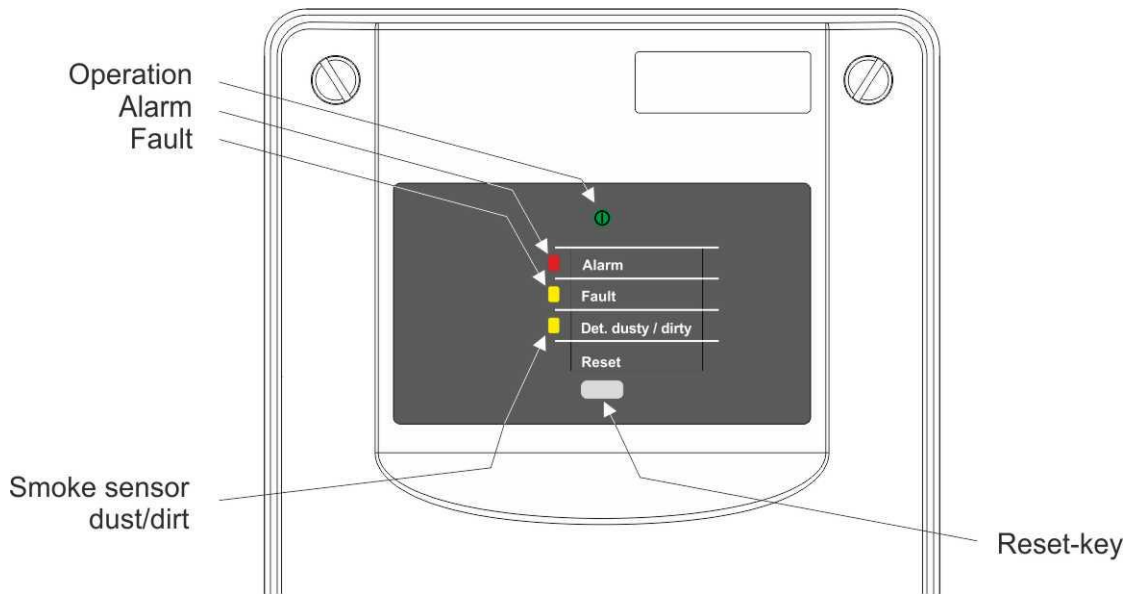





Fig. 49 Display and operating panel of ASD 531

8.1 Indicators

The following events are indicated by LEDs on the control unit:

Operation, fault, alarm, pre-signal 1, pre-signal 2, pre-signal 3, detector dusty, detector dirty.
Depending on the event, the LEDs may be continuously lit or flash with certain frequencies.

	Off	Slow flashing (2s T)	Medium flashing (1s T)	Fast flashing (½ s T)	On	State
 Operation	x					System disconnected from power
					x	System connected to power
 Alarm		x				Pre-signal 1
			x			Pre-signal 2
				x		Pre-signal 3
 Fault			x			Pipe blockage/pipe breakage, delay time running
				x		System inactive (external reset) or smoke sensor off (from FACP)
 Det. dusty/dirty					x	Fault triggered → Pipe blockage/breakage or fan tachometer signal missing
		x				Detector Filter fault
			x			Detector dusty
				x		Detector dirty
					x	Smoke sensor fault

8.2 Operation

The operation of the ASD 531 aspirating smoke detector in normal operation is limited to resetting a triggered event (alarm/fault).

Triggered events (alarms, faults) are reset with the "Reset" key on the control unit on the ASD 531.

The reset is possible only if the triggered event is no longer pending (e.g. smoke sensor no longer has smoke).

8.3 Lamp test

Used as a functional test of the indicators.

- Press the "Reset" key on the control unit or "Set/Res" on the AMB 31 for a 10 sec
 - All the control unit LEDs flash 5x
 - All LEDs (apart from "Wdog") on the AMB 31 flash 5x

8.4 Start filter replacement function

Start filter replacement function by pressing the "Reset" key longer than 15 s (provided the filter function is activated).

Note: the lamp test starts after 10 s.

When the "Filter replacement" procedure is activated, the ASD goes into the "Isolate" state (ASD in fault, LED "Fault").

The "Filter replacement" procedure is terminated by pressing the "Reset" key again.

8.5 Operation from SecuriFire

See document "Special fire detector integration in SecuriFire" (under preparation).

9 Maintenance

The statutory national directives (e.g. DIN VDE 0833-1, Cantonal Fire Insurance Union) governing maintenance must be observed.

Servicing work on the ASD 531 is periodically necessary and may be necessary after an event (fire, fault).

To prevent triggering fire control installations, remote alarms and extinguishing areas when maintenance work is performed, it is absolutely necessary that they are blocked or switched off beforehand.

Personnel:

Maintenance work may only be carried out by the manufacturer or by authorised personnel trained by the manufacturer.

The operator is obligated to conclude a service agreement with the manufacturer or with an installer authorised by the manufacturer if the operator does not have the required service personnel trained by the manufacturer.

9.1 Maintenance

Maintenance interval:

At least once a year in a clean environment.

In an environment with a high level of dust pollution (increased risk of dirt hazard), the maintenance interval is reduced as far as is necessary to guarantee functional reliability.

If dust filter units are used, the service life of the filter inserts play a role in the maintenance interval. Depending on the level of dust and dirt in the object, filter service may vary greatly. The optimum filter service life is to be determined on site on a case by case basis.

If filter-boxes or dust filter units are installed in applications, a "simplified" maintenance can be performed only on the filter-boxes or dust filter boxes as described in Sec. 9.1.1

Maintenance work:

1. Preparation
Block or switch off fire incident control and remote alerting on the superordinate FACP.
2. Cleaning the detector housing exterior
Clean the exterior surfaces of the closed detector housing.
Check air outlet opening for possible soiling and clean if necessary.
Only **use non-aggressive** cleaning agents e.g. use soap and water or similar!
3. Cleaning of sampling pipe tube network
Usually only the sampling holes must be cleaned.
In applications where dirt is a major issue, it may be necessary to clean inside the sampling pipe (blow out with compressed air or nitrogen, use cleaning kit).
Only **use non-aggressive** cleaning agents e.g. use soap and water or similar!
4. Check correct seating (no leakage)
 - Check that the sampling pipe inlet is correctly seated on the detector housing.
 - If present: check that plug-in transitions from rigid to flexible pipe sections are correctly seated.
5. Checks in the detector housing interior
Open detector housing.
 - Measure the operating voltage on terminal 1 (+), 2 (-) → 21.6 to 27.6 VDC (with 24 VDC power supply).
 - Read out the airflow value on the airflow indicator (see Sec. 7.1) and compare with the commissioning protocol. If a deviation greater than +- 2 LED levels is shown, a check of the sampling pipe as follows is advisable:
An **increase** in the value (greater than 100%) tends to indicate **pipe breakage** → Check the sampling pipe for leakage (connection points, fittings, etc.).
A **decrease** in the value (lower than 100%) tends to indicate **pipe blockage** → Check the sampling pipe for blockage, clean in accordance with **item 11** or **12**.
 - If the airflow value is still outside the tolerance range, the airflow monitoring will have to be readjusted (initial reset in accordance with Sec. 6.6).



Notice

A new initial reset is not usually necessary after cleaning work on the sampling holes (cleaning restores the commissioning state). If an initial reset is necessary nonetheless after the work set out under **Item 5**, it may **only** be carried out once it has been ensured that all possible measures for cleaning the sampling pipe have been carried out (incl. a new filter cartridge).

If an initial reset is carried out with blocked sampling holes, there is the danger that insufficient air samples or no air samples will be aspirated and hence the ASD 531 can no longer trigger an alarm.

6. Cleaning the detector housing interior
 - Switch off the ASD supply (unplug terminal block 1/2 and if necessary 3/4 on the AMB 31). After disconnecting the ribbon cable from the smoke sensor, carefully remove the sensor from the ASD.
 - Use a soft, dry paintbrush to clean the inside of the smoke sensor chamber and the insect protection screen. Oil-free compressed air or nitrogen can also be used for cleaning.
 - Reinsert the smoke sensor in the ASD and connect.
7. Check of fault and alarm release
 - Switch the ASD back on again and wait until the fan has reached its definitive speed (at least 5 minutes).
 - Check the fault and alarm triggering and the correct alarm actuation on the FACP as described in Sec. 6.7.
8. Logging
 - Enter and sign for all measurements and tests carried out in the commissioning protocol.
 - Store the completed commissioning protocol in the ASD.
 - If required, a copy can be made and stored in the system dossier.
9. Finishing work
 - Close detector housing.
 - Unblock or switch on fire incident control and remote alerting on the superordinate FACP.
10. Check that the supply voltage on the FACP is set in compliance with maintenance instructions for the control panel.

Cleaning of sampling pipe, accessory parts and the airflow sensor

11. If it is necessary to clean the sampling pipe as indicated under **item 5**, carry out the following measures (possibly also according to **item 12**):
 - Clean all sampling holes in the entire sampling pipe tube network. Tobacco pipe cleaners can be used for this purpose.
 - If the sampling holes are not accessible, the entire sampling pipe tube network can be blown out from the detector housing using oil-free compressed air or nitrogen. This is done via the manual ball valve or from the loosened screw-junction piece (pipe connection) of the last accessory part in the direction of the sampling pipe network.
 - Open the accessory parts (water retaining box, dust filter unit, detector boxes) where fitted, and clean with a soft dry paintbrush. Oil-free compressed air or nitrogen can also be used for cleaning. Replace the filter cartridge in the filter-box or dust filter unit (see also data sheet T 140 705). Close all the accessory parts again after cleaning.
 - After cleaning the sampling pipe, re-connect it correctly to the ASD 531.
12. In applications where dirt is a major issue, it may be necessary to clean the airflow sensor. As indicated in Sec. xxx detach the sensor from the holder and use a soft, dry paintbrush to clean it → **Attention: do not clean or touch the sensor surface with your fingers**. Then reinsert the airflow sensor as indicated in Sec. 9.2.3 → Make sure it is correctly seated inside the holder.

9.1.1 Filter replacement on dust filter units

If a "Filter fault (service life exceeded)" occurs when filter monitoring is activated and after expiry of the configured filter service life, the filter element in a dust filter unit must be replaced. See also Sec. 7.3.

To replace the filter element, the "Filter replacement" function must be activated on the ASD (via the "Reset" key or BasiConfig). When filter replacement is activated, the aspirating smoke detector is set to the "Isolate" state. This insures that falling dust particles from the filter element do not cause a false alarm during the replacement work. After the filter has been replaced, the "Filter replacement" procedure is completed by pressing the "Reset" key on the ASD. This cancels the "Isolate" state and resets the fault on the ASD. "Filter service life" monitoring is restarted at 0.

9.2 Replacement of components



Notice

Defective units such as the AMB 31, smoke sensor, air flow sensor and fan may only be replaced in the de-energised state (with terminal block 1/2 and possibly 3/4 unplugged from the AMB 31).

9.2.1 Replacing the smoke sensor

The smoke sensor must be replaced if defective or if there is a soiling message.

Removal of the smoke sensor

- Pull out ribbon cable (7) on the AMB 31 main board (8).
- Loosen the two lock clamps (6) in the ASD map case and remove the smoke sensor.

Fitting of the smoke sensor

- Only remove the smoke sensor from the protective packaging directly before insertion into the detector housing.
- Before installing the smoke sensor check whether the insect protection screens (1) are properly fitted to the smoke sensor chamber at the air inlet and outlet.
- The smoke sensor chamber (2) must be absolutely free of any dirt and/or dust. Clean if necessary.
- Check the installation position when installing the smoke sensor (0). The connector plug of the smoke sensor (3) must face away from the slots of the option modules (4). The anti-twist rib on the smoke sensor case (5) prevents an incorrect installation position.
- The smoke sensor is secured inside the ASD map case using the two lock clamps (6). Connect the ribbon cable (7) supplied with the smoke sensor to the smoke sensor (large ribbon cable connector (3)) and to the AMB 31 main board (small ribbon cable connector (8)).

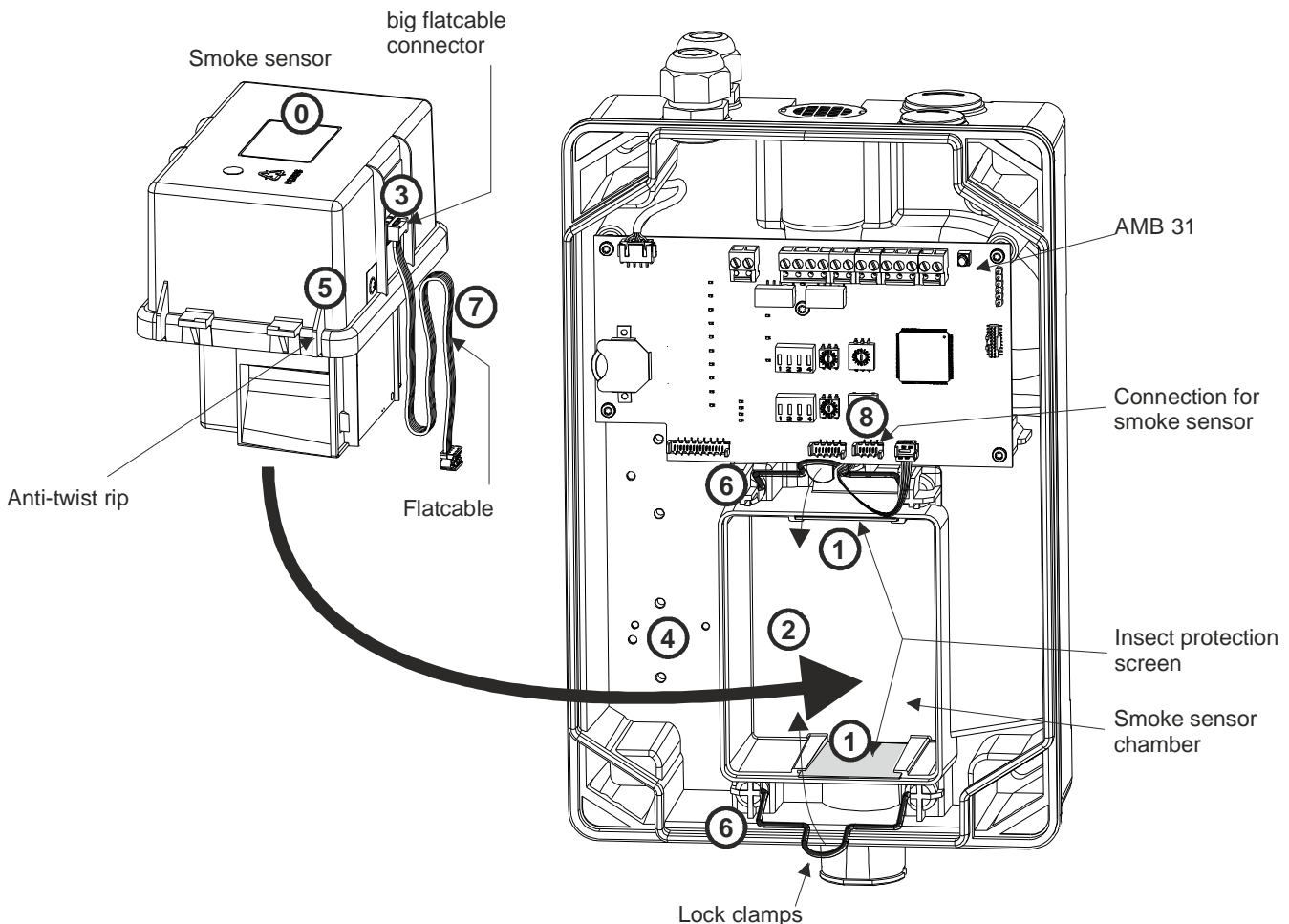

Fig. 50 Installing the smoke sensor

9.2.2 Replacement of AFU 32 aspirating fan unit

- First dismantle the AMB 31 [main board](#).
 - To do so, carefully unplug all the internal cable connections.
 - Unplug the fan connector plug.
 - The plug-in terminals 1 to 15 do not necessarily have to be unplugged.After removing the retainer screws of the AMB 31 using a Torx T10 screwdriver, the AMB 31 can be lifted up towards the cable infeeds.
 - The retaining screws on the aspirating fan unit are then accessible.
- Remove the two screws A of the aspirating fan unit with a Torx T15 screwdriver (see Fig. 51).

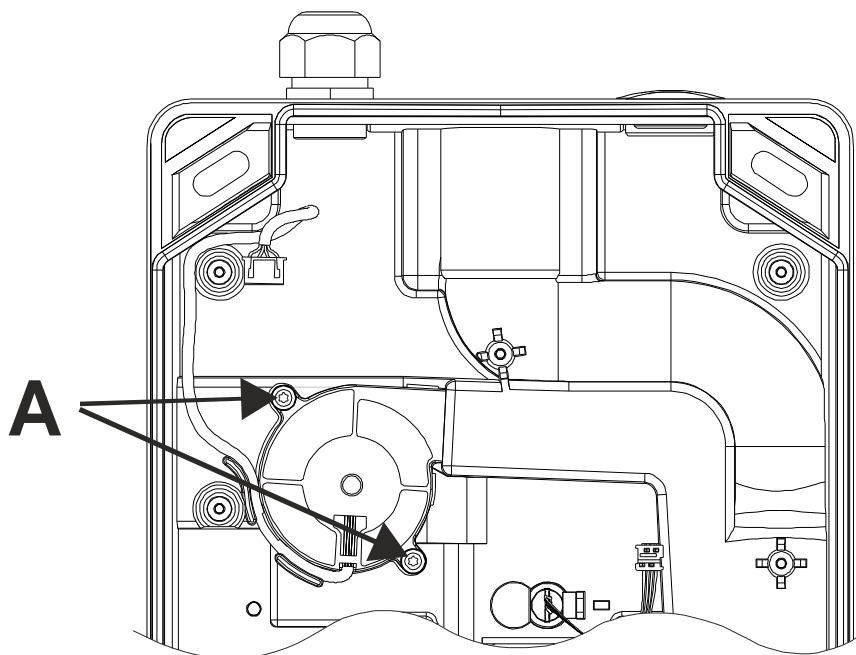

Fig. 51 Removing the aspirating fan unit



Notice

After replacing the aspirating fan unit, a new initial reset is imperative (see Sec. 6.6).

9.2.3 Replacing the air flow sensor



Notice

When removing and mounting the air flow sensor, make sure that the sensor element is not damaged (i.e. does not break). Do not pull on the connection wire.

After replacing an air flow sensor, a new initial reset is imperative (see Sec. 6.6).

- Unplug connector plug A of the air flow sensor on the AMB 31.
- Gently push the lock tab B towards the connector. The sensor can then be carefully pulled out of its holder by gripping tab C with thumb and index finger → Attention: do not pull on the supply cable of the sensor.
- To install the new air flow sensor proceed in the reverse sequence. It is important to note the installation position (anti-twist safeguard) of the sensor and make sure it is correctly seated in its holder. To do this, press the sensor on grip tab C towards the housing base until the lock tab snaps over the sensor → **Attention: do not press the connection wires of the sensor.**

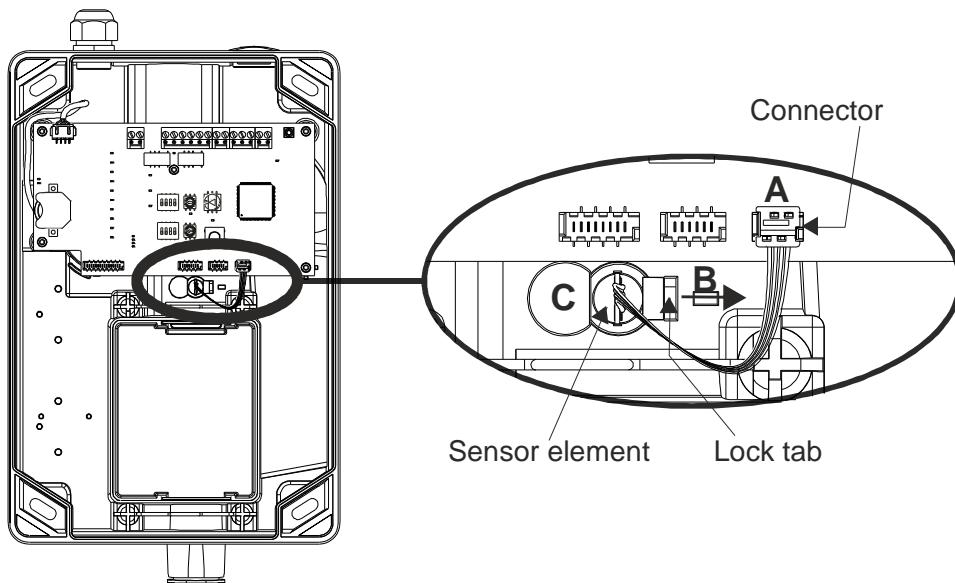

Fig. 52 Removing the air flow sensors

9.2.4 Replacing the AMB 31 Main Board

Design

- Unplug all plug-in terminals from the AMB 31 [main board](#) with installation wires.
- Also carefully unplug all internal cable connections (ribbon cable connectors).
- Remove the five retainer screws of the AMB 31.

Installation:

- To install the AMB 31, proceed in the reverse sequence as for disassembly.



Notice

When connecting the new AMB 31, pay attention to the terminal and flat cable connector assignments (see also Fig. 3).

After replacing the AMB 31, possible customer-specific configurations and project-specific settings from the "ASD [PipeFlow](#)" configuration software must be carried out once again. Proceed according to ch 0.

A new initial reset is also imperative (see Sec. 6.6).

10 Fault rectification

10.1 Fault events and their possible causes / rectification

If a fault occurs, its cause can be localised by using the event code in the event memory (see Sec. 7.10 Reading out the EM). The table below lists the event codes for possible fault states and how to rectify them. A list of all the event codes is provided in Sec. 7.10.3.2,



Notice

Multiple codes: If there are multiple events for any given event group, the display readings are added together.
Example: Display **012** = event code **004** and **008**.

G10, smoke sensor events			
Code	Meaning:	Check:	Possible causes and remedy:
002	Dust	Check smoke sensor chamber, sampling pipe and dust filter unit for dust deposits	<ul style="list-style-type: none"> • Clean interior of smoke sensor chamber and insect protection screen • Check and clean sampling pipe and, if necessary, dust filter unit. • Replace smoke sensor
004	Dirt	Check smoke sensor chamber, sampling pipe and dust filter unit for dirt deposits	<ul style="list-style-type: none"> • Clean interior of smoke sensor chamber and insect protection screen • Check and clean sampling pipe and, if necessary, dust filter unit. • Replace smoke sensor
G11, smoke sensor faults, part 1			
Code	Meaning	Check:	Possible causes and remedy:
001	ASD <> smoke sensor communications	Ribbon cable connection AMB, smoke sensor	<ul style="list-style-type: none"> • Ribbon cable incorrectly attached or defective → check, replace. • Smoke sensor defective → replace. • AMB defective → replace
002	Unknown smoke sensor type (production fault)	Smoke sensor	<ul style="list-style-type: none"> • Replace smoke sensor
008	Invalid parameters, smoke sensor (production fault)	Smoke sensor	<ul style="list-style-type: none"> • Replace smoke sensor
G12, smoke sensor faults, part 2			
Code	Meaning	Check:	Possible causes and remedy:
001	Measuring chamber	Smoke sensor	<ul style="list-style-type: none"> • Smoke sensor defective → replace.
002	Temperature	ASD ambient temperature Smoke sensor	<ul style="list-style-type: none"> • Adhere to ambient temperature specifications. • Smoke sensor defective → replace
004	Supply voltage	Check ASD operating voltage AMB, smoke sensor	<ul style="list-style-type: none"> • Set operating voltage correctly • AMB defective → replace • Smoke sensor defective → replace
008	EEPROM access error	Smoke sensor	<ul style="list-style-type: none"> • Smoke sensor defective → replace
016	EEPROM invalid data	Smoke sensor	<ul style="list-style-type: none"> • Smoke sensor defective → replace
032	Manufacturing	Smoke sensor	<ul style="list-style-type: none"> • Smoke sensor defective → replace
G16, smoke sensor, filter faults			
Code	Meaning	Check:	Possible causes and remedy:
001	Filter fault (service life exceeded)	Filter service life for the object-specific dust and dirt levels present	<ul style="list-style-type: none"> • Replace filter element • Increase filter service life if necessary

Fault rectification

G30, airflow monitoring sampling pipe			
Code	Meaning	Check:	Possible causes and remedy:
001	Pipe blockage sampling pipe or filter element is not inserted (if DFU 911S is used)	Sampling pipe, air outlet on the ASD, dust filter unit, filter element soiled (or "not inserted" in DFU 911S), LS sensor	<ul style="list-style-type: none"> • Check sampling pipe for pipe blockage (sampling holes, air outlet) • Check and clean dust filter unit • Filter element is not inserted (if DFU 911S is used) • Check and clean LS sensor
002	Pipe breakage	Sampling pipe, LS sensor	<ul style="list-style-type: none"> • Check sampling pipe for pipe breakage • Check maintenance hole • Sampling pipe not correctly fitted • Junctions open (fittings, flexible transitions) • Check and clean LS sensor
004	Invalid LS-Ü parameters	sampling pipe	<ul style="list-style-type: none"> • Outside of range (working point) • Check and clean LS sensor • LS sensor defective → replace
008	Air flow sensor, defective / missing	Air flow sensor Connection line	<ul style="list-style-type: none"> • Not fitted, not mounted • Connection line defective • LS sensor defective → replace
G50, fan faults			
Code	Meaning	Check:	Possible causes and remedy:
001	Tacho signal missing	Check fan terminals (white wire)	<ul style="list-style-type: none"> • Poor connection • Fan defective • AMB defective → replace
002	Motor regulation outside range	Check ASD operating voltage, Check fan connection	<ul style="list-style-type: none"> • Set operating voltage correctly • Fan defective → replace • AMB defective → replace
004	Motor current too low	Fan unit, fan connection	<ul style="list-style-type: none"> • Fan mechanically blocked • Fan defective → replace • AMB defective → replace
G60, initial reset faults			
Code	Meaning	Check:	Possible causes and remedy:
004	Initial reset time-out	Motor run-in time	<ul style="list-style-type: none"> • Failure to observe waiting time before initial reset • Carry out new initial reset
008	Invalid parameters for initial reset	Sampling pipe specifications	<ul style="list-style-type: none"> • Observe sampling pipe specifications • Initial reset was interrupted (by "ASD Off") → new initial reset
G70, RIM faults			
Code	Meaning	Check:	Possible causes and remedy:
001	RIM defective / missing	Ribbon cable connection Module	<ul style="list-style-type: none"> • Ribbon cable incorrectly attached or defective → check, replace. • Module removed and not logged off. • Module defective → replace
064	Incompatible RIM	Note the production version, should be greater than 181214	<ul style="list-style-type: none"> • Replace RIM
128	too many RIMs	Number of RIMs	<ul style="list-style-type: none"> • Only 1 RIM permitted!
G71, XLM / ML-SFD faults			
Code	Meaning	Check:	Possible causes and remedy:
004	ML-SDF defective / missing	Ribbon cable connection Module	<ul style="list-style-type: none"> • Ribbon cable incorrectly attached or defective → check, replace. • Module removed and not logged off. • Module defective → replace
008	too many ML-SFD connected or not permitted module combination	Number of ML-SFDs Module combination	<ul style="list-style-type: none"> • Only 1 ML-SFD permitted! • no combination with XLM, possible
016	XLM fault, defective / missing	Ribbon cable connection Module	<ul style="list-style-type: none"> • Ribbon cable incorrectly attached or defective → check, replace. • Module removed and not logged off. • Module defective → replace
064	XLM fault, too many XLMs	Number of XLMs	<ul style="list-style-type: none"> • Only 1 XLM permitted!

G73, SD memory card faults			
Code	Meaning	Check:	Possible causes and remedy:
001	SD memory card fault, missing or defective	SD memory card	<ul style="list-style-type: none"> • SD memory card was removed without logging off • SD memory card defective → replace
002	SD memory card communication error	SD memory card AMB	<ul style="list-style-type: none"> • SD memory card defective → replace • AMB defective → replace
G80, AMB faults			
Code	Meaning	Check:	Possible causes and remedy:
004	Undervoltage fault	Operating voltage < 13 VDC Conductor cross-section	<ul style="list-style-type: none"> • Conductor cross-section too weak → must be enlarged. • Voltage of the power supply not OK → check and correct if needed
008	Clock fault	Lithium battery Clock setting	<ul style="list-style-type: none"> • Isolation strip still present on the lithium battery → remove. • Clock is not set • Lithium battery defective → replace
G81, Operating system faults			
Code	Meaning	Check:	Possible causes and remedy:
all	See Sec 7.10.3.2	FW / AMB	<ul style="list-style-type: none"> • HW reset • FW upgrade • AMB defective → replace

11 Technical data

Type	ASD 531		
Supply voltage range	(UL/FM: 16,4 to 27) 14 to 30		VDC
Maximum power consumption, measured at	14 VDC ①	24 VDC	
ASD 531	Quiescent / fault	approx. 110	approx. 75 mA
	Alarm	approx. 120	approx. 80 mA
	additionally with RIM 36 (all relays triggered)	approx. 30	approx. 15 mA
	additionally with XLM 35 / ML-SFD	approx. 15	approx. 5 mA
Switch-on current peak ② (caused by EMC protection elements on the ASD supply input)	approx. 5A for max. 1 ms		
Sampling pipe length	max. 75 m		
Length to farthest sampling hole	max. 40 m		
Max. number of sampling holes	Class A	max. 6	
	Class B	max. 8	
	Class C	max. 12	
Sampling pipe diam., typical (inner/outer)	Ø 20 / 25		mm
Sampling hole diameter	Ø 2 / 2.5 / 3 / 3.5 / 4 / 4.5 / 5 / 5.5 / 6 / 6.5 / 7 mm		
Response range	EN 54-20, Class A, B, C		
Protection type compliant with IEC 60529 / EN 60529	54		IP
Ambient conditions compliant with IEC 60721-3-3 / EN 60721-3-3	3K5 / 3Z1		class
Extended ambient conditions:			
• Detector housing temperature range	(UL: -10 to +40)	-10 – +55	°C
• Sampling pipe temperature range		-10 – +55 ③	°C
• Max. permissible temperature fluctuation in detector housing and sampling pipe operation		20 ③	°C
• Max. permissible storage temperature for detector housing (without condensation)		-30 – +70	°C
• Ambient pressure of detector housing and sampling pipe (sampling holes)	must be identical		
• Humidity ambient condition for detector housing (transient without condensation)	95 ③	% rel. h	
• Humidity ambient condition (continuous)	70 ③	% rel. h	
Max. loading capacity, relay contact	(UL: 30)	50	VDC
		1	A
		30	W
Max. loading capacity per OC output (dielectric strength 30 VDC)	100		mA
Plug-in terminals	2.5		mm ²
Cable entry for cable Ø	Ø 5 – 12 (M20) / Ø 9 – 18 (M25) mm		
Sound pressure level	25.0		dB (A)
Housing material	ABS blend, UL 94-V0		
Housing colour	grey 280 70 05 / anthracite violet 300 20 05		RAL
Approvals	EN 54-20 / FM 3230-3250 / ULC-S529 3rd Ed		
VdS approval	G 215100		
Dimensions	195 x 333 x 140		mm
Weight (without/with packaging)	1,950/2,250		g

- ① Power consumption at maximum permitted voltage drop in the electrical installation (decisive value for calculating the conductor cross-section).
- ② May cause the protective circuit to trigger immediately in the case of power supplies with overload protective circuits (primarily in devices with no emergency power supply and output current of < 1.5 A).
- ③ Lower or higher temperature ranges are also possible subject to consultation with the manufacturer. The manufacturer must be consulted if the device is used in the condensation range.

12 List of figures

Fig. 1 Design.....	17
Fig. 2 Mechanical design	22
Fig. 3 Block diagram	23
Fig. 4 AMB 31	24
Fig. 5 XLM 35	25
Fig. 6 ML-SFD.....	25
Fig. 7 RIM 36	26
Fig. 8 "ASD PipeFlow" program interface.....	29
Fig. 9 Sampling pipe definitions	31
Fig. 10 Size of sampling holes (I-shaped)	32
Fig. 11 Size of sampling holes (H-shaped).....	32
Fig. 12 Size of sampling holes (U/T-shaped)	32
Fig. 13 Size of sampling holes (E-shaped).....	32
Fig. 14 Examples of planning with "ASD PipeFlow" calculation.....	33
Fig. 15 Types of equipment monitoring layouts (examples)	34
Fig. 16 Detector housing and tube network in the same room	37
Fig. 17 Detector housing and tube network not in the same room.....	37
Fig. 18 Detector housing and tube network in different climate zones with air recirculation	38
Fig. 19 All sampling holes and the air outlet must be in the same climate zone	38
Fig. 20 Mounting position and pipe entries on the detector housing	39
Fig. 21 Detector housing dimensioned drawing	40
Fig. 22 Detector housing drilling plan	40
Fig. 23 Fastening the detector housing	40
Fig. 24 Turning the labelling strips	41
Fig. 25 Turning the snap locks	41
Fig. 26 Position of the snap locks.....	41
Fig. 27 Connection of the reset input	44
Fig. 28 Connecting the relay contacts	45
Fig. 29 Connecting the OC outputs	46
Fig. 30 Connection to SecuriFire addressable loop.....	46
Fig. 31 Installing additional modules	47
Fig. 32 UMS 35.....	47
Fig. 33 Terminal assignments AMB 31, XLM 35 / ML-SFD and RIM 36.....	48
Fig. 34 90° bend, branching point	51
Fig. 35 Vertical sampling pipe	51
Fig. 36 Cutting the tubes.....	51
Fig. 37 Assembling the tubes.....	51
Fig. 38 Creating the sampling holes.....	52
Fig. 39 Mounting clips	52
Fig. 40 Mounting the ceiling bushing.....	53
Fig. 41 Screw-free fastening of a sampling fixture.....	54
Fig. 42 Transition from fittings to flexible tube	55
Fig. 43 Using sampling funnels	55
Fig. 44 Mounting accessory parts	56
Fig. 45 Commissioning workflow	57
Fig. 46 Detector housing opened for commissioning.....	58
Fig. 47 Control and display elements on the AMB 31.....	59
Fig. 48 Airflow indicator.....	66
Fig. 49 Display and operating panel of ASD 531.....	79
Fig. 50 Installing the smoke sensor.....	84
Fig. 51 Removing the aspirating fan unit.....	85
Fig. 52 Removing the air flow sensors	86